

Skoda Rapid 06/2015-

Partnr.: SK-025-H1U

- Fitting instructions electric wiring kit tow bar with 13-P socket up to DIN/ISO Norm 11446.
- We would expressly point out that assembly not carried out properly by a competent installer will result in cancellation of any right to damage compensation, in particular those arising by virtue of the product liability act.
- Contents of these kits and their fitting manuals are subject to alteration without notice, please ensure that these instructions are read and fully understood before commencing installation.
- Do not overload circuits; the maximum loads per connection are detailed in this manual.
- Attention! Before Installation, please read this manual carefully and inform your customer to consult the vehicle owners manual to check for any vehicle modifications required before towing.
- In the event of functional problems, troubleshooting must be limited to about 0.5 hours, contact the technical support:
t.skinner@ecs-electronics.com / 07440 202 052.



Part list

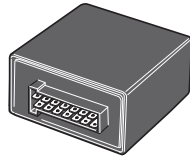
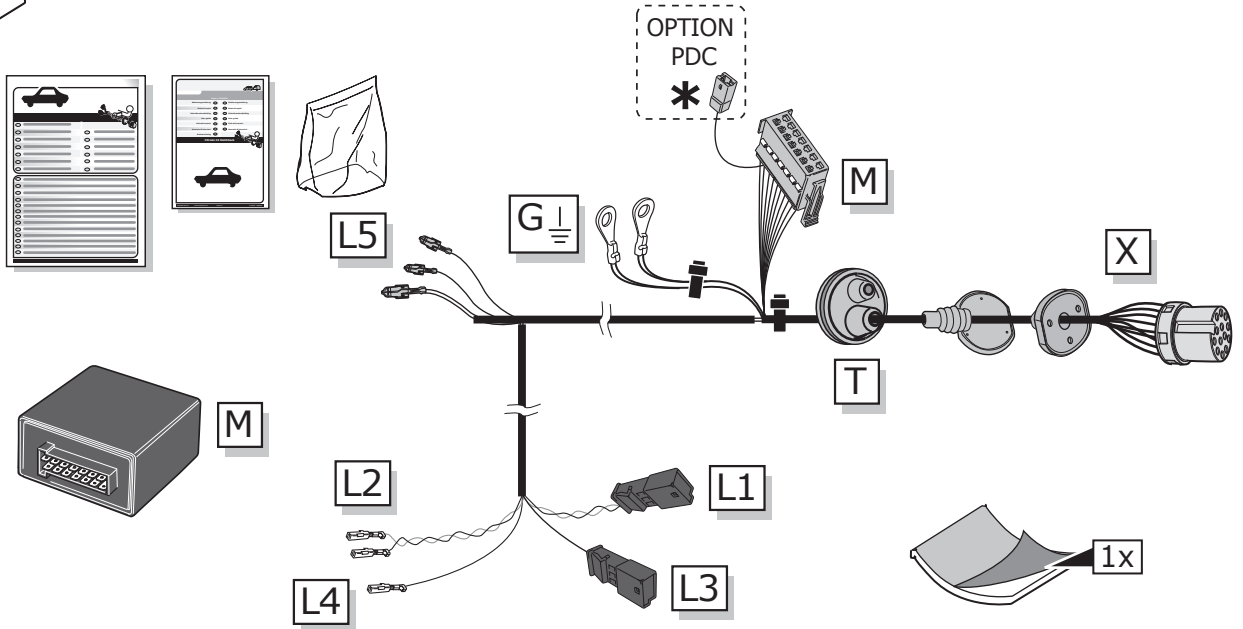
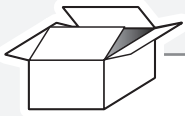

M

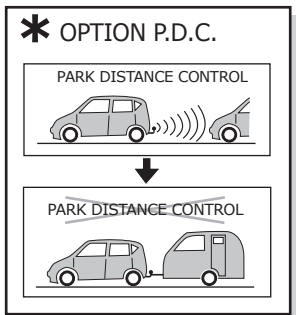

X

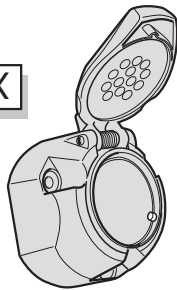

30x



3x

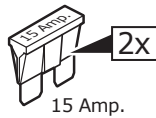

2x

15 Amp.



2x

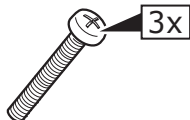

3x

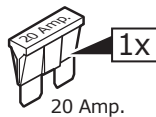

1x

20 Amp.

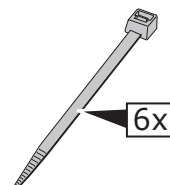

6x

ROUTING

Skoda Rapid HB

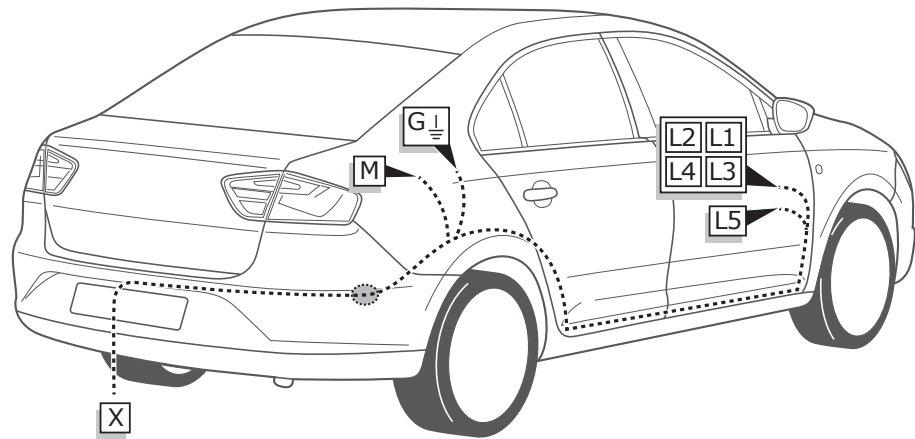

Skoda Rapid Spaceback

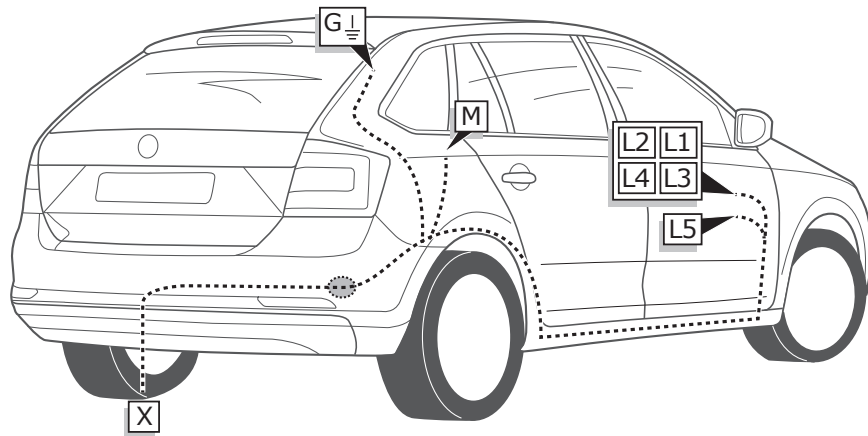

1

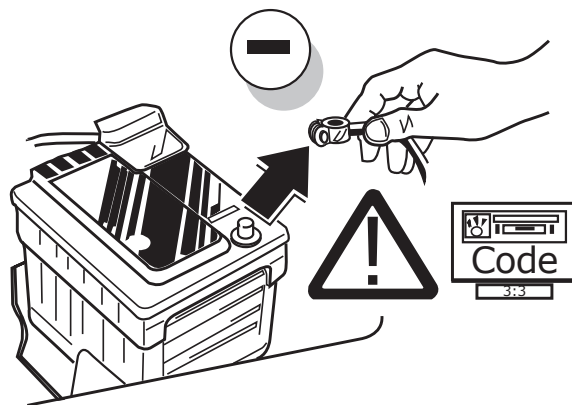

2

Skoda Rapid HB

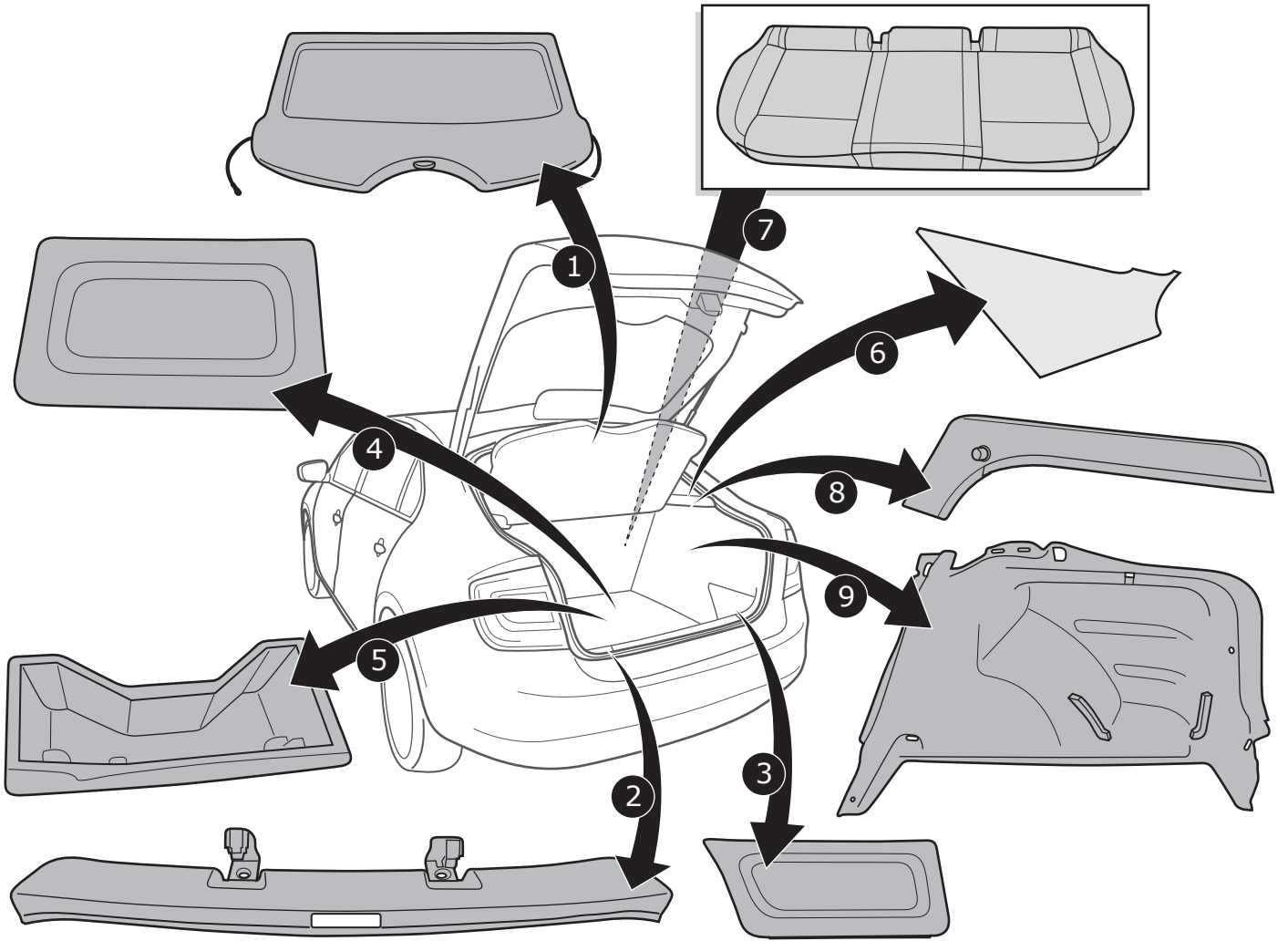

3

Skoda Rapid Spaceback

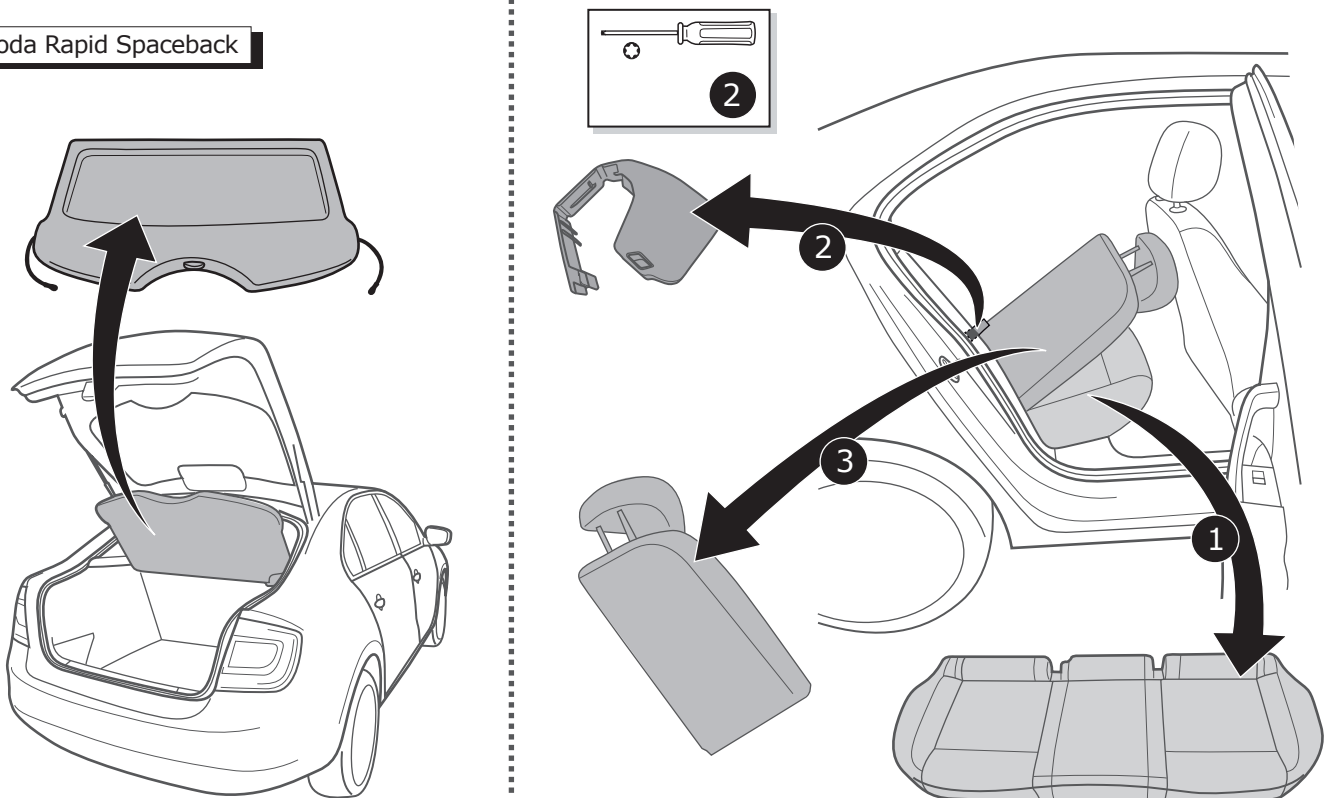

4

Skoda Rapid Spaceback

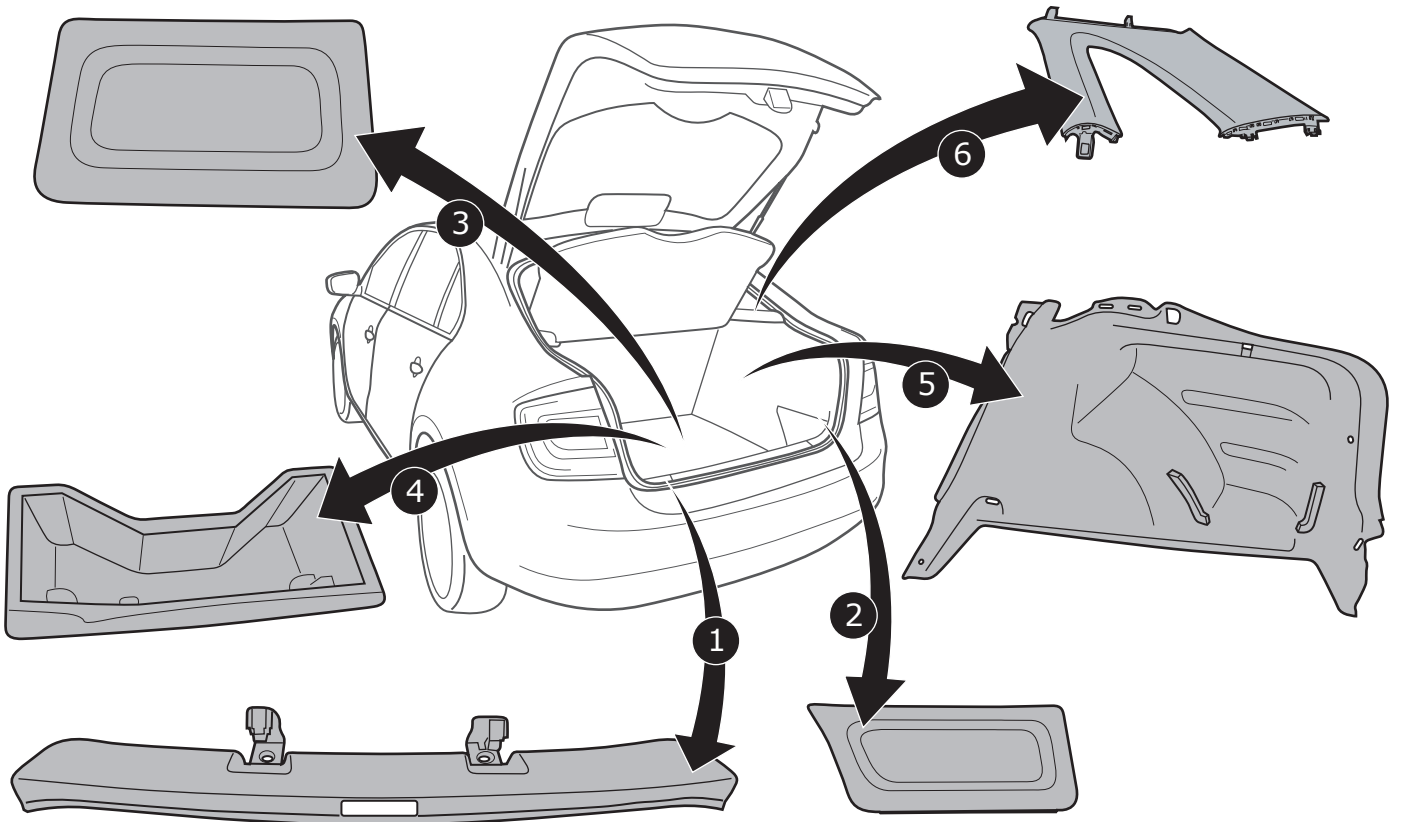

5

All models

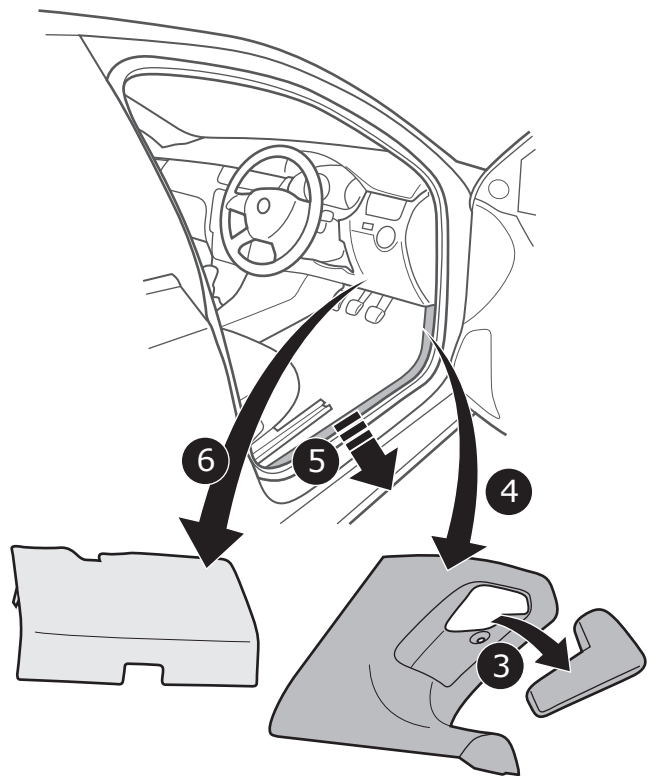
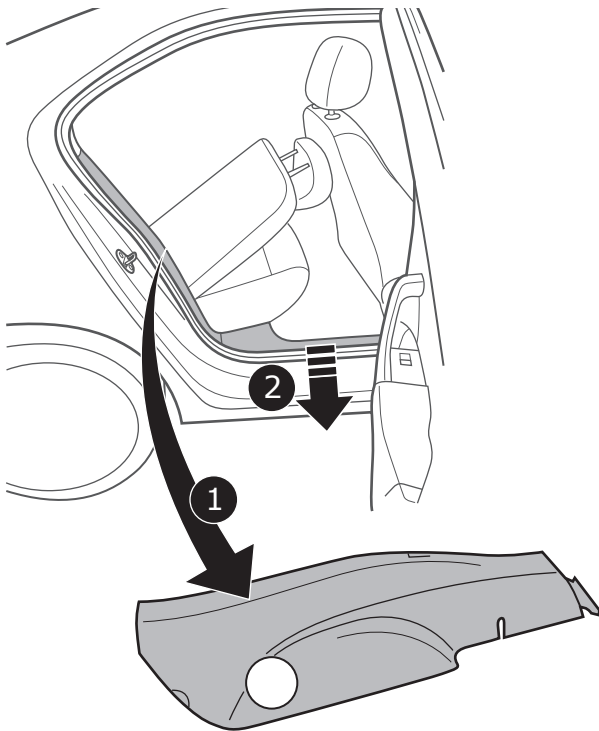

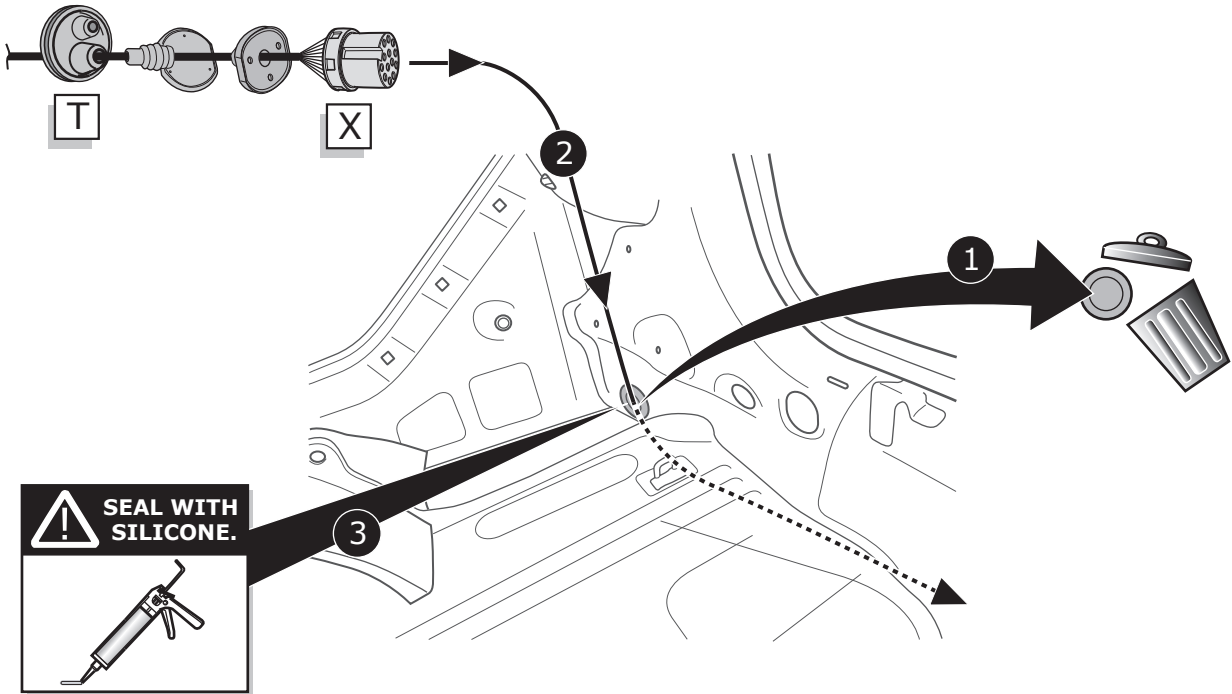
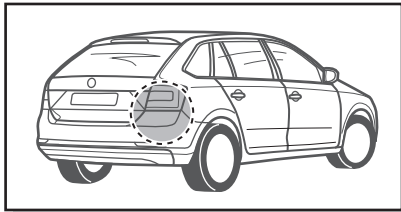
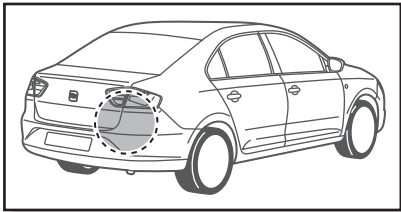

A

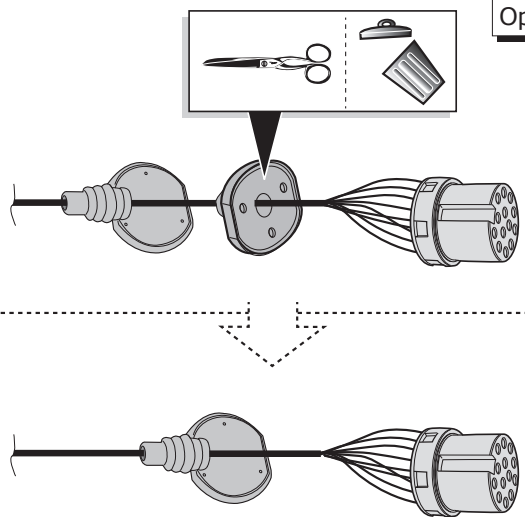
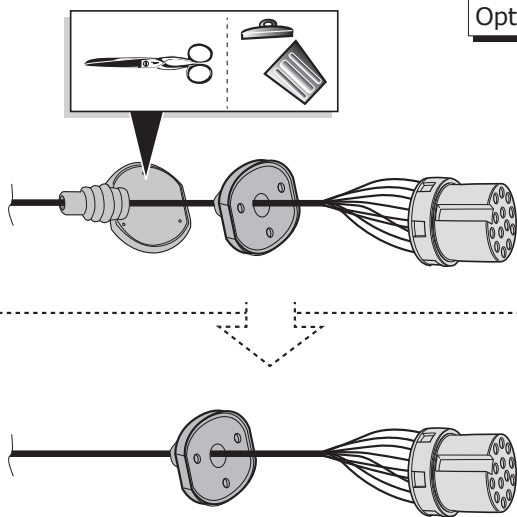

INFO

SOCKET CONNECTION



Pag. 15

B

Option 1

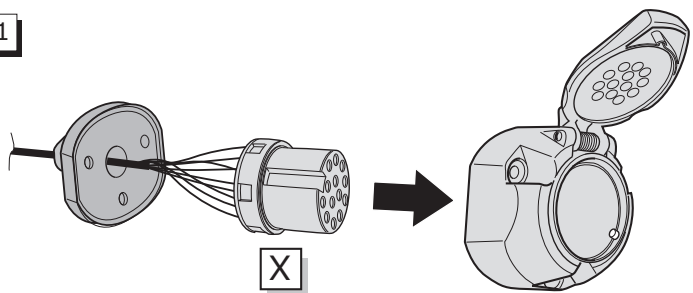

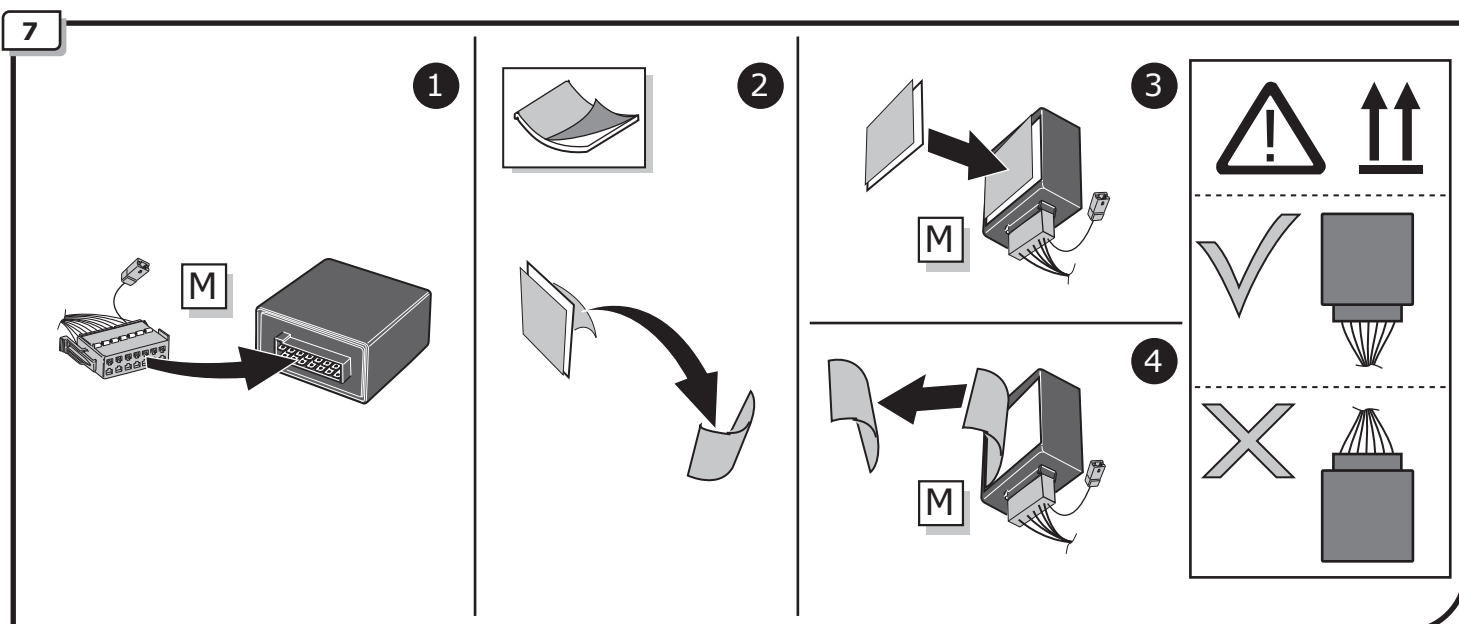
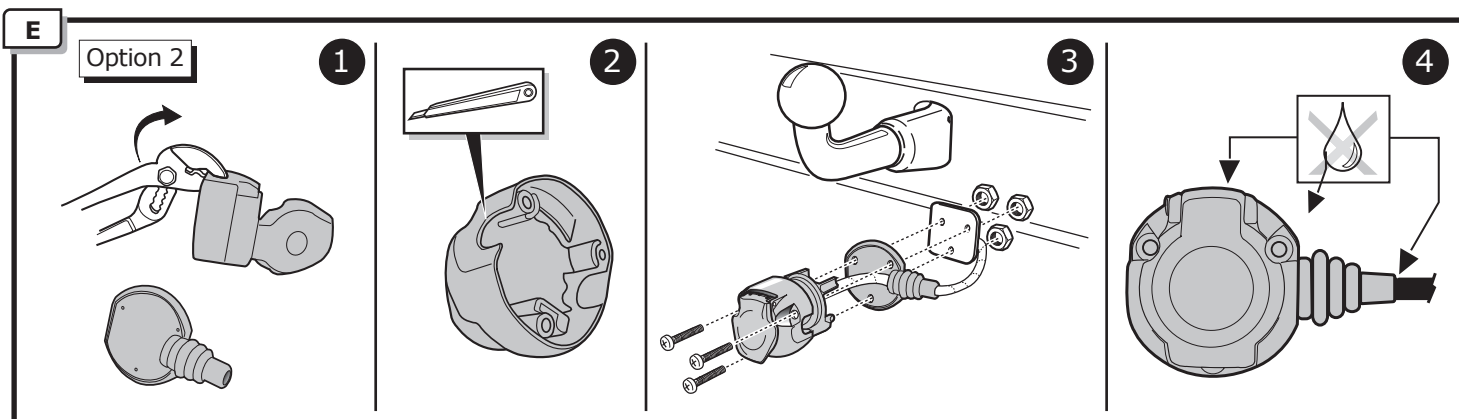
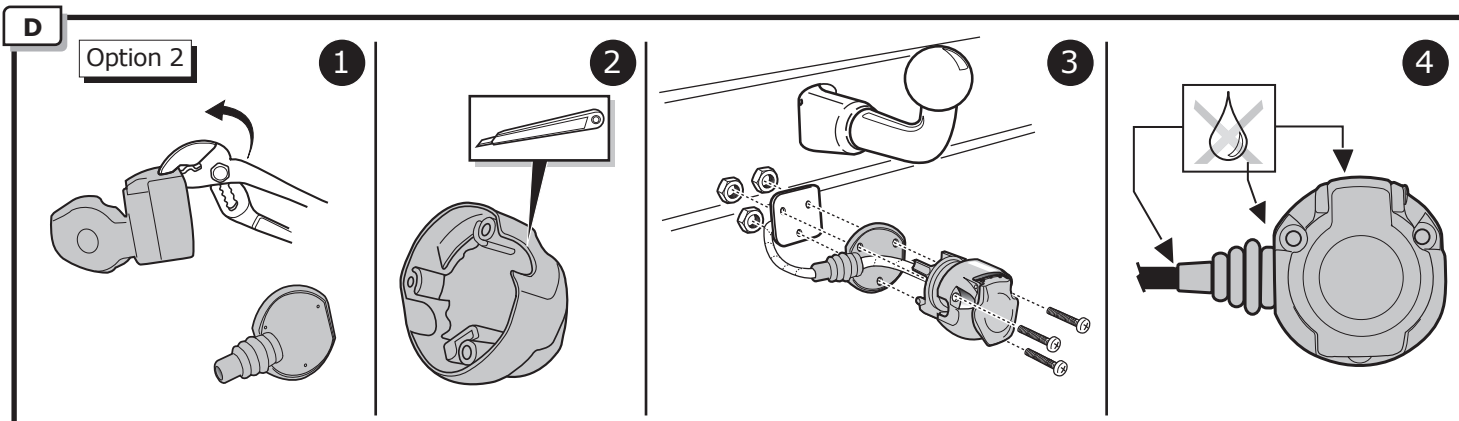
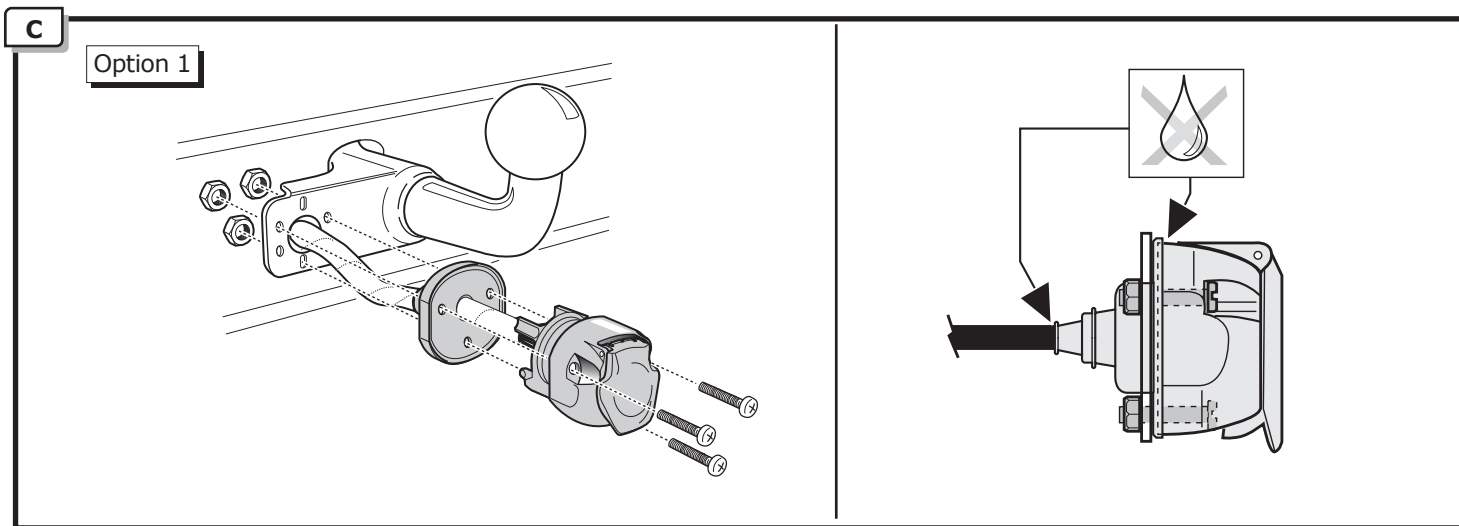

8

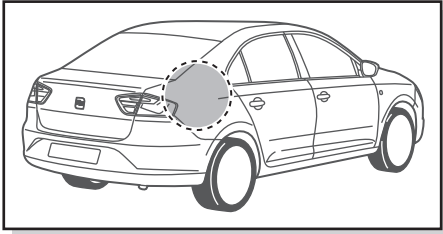

Skoda Rapid HB

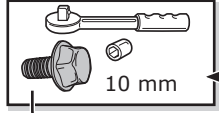

10 mm

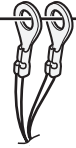

1

2

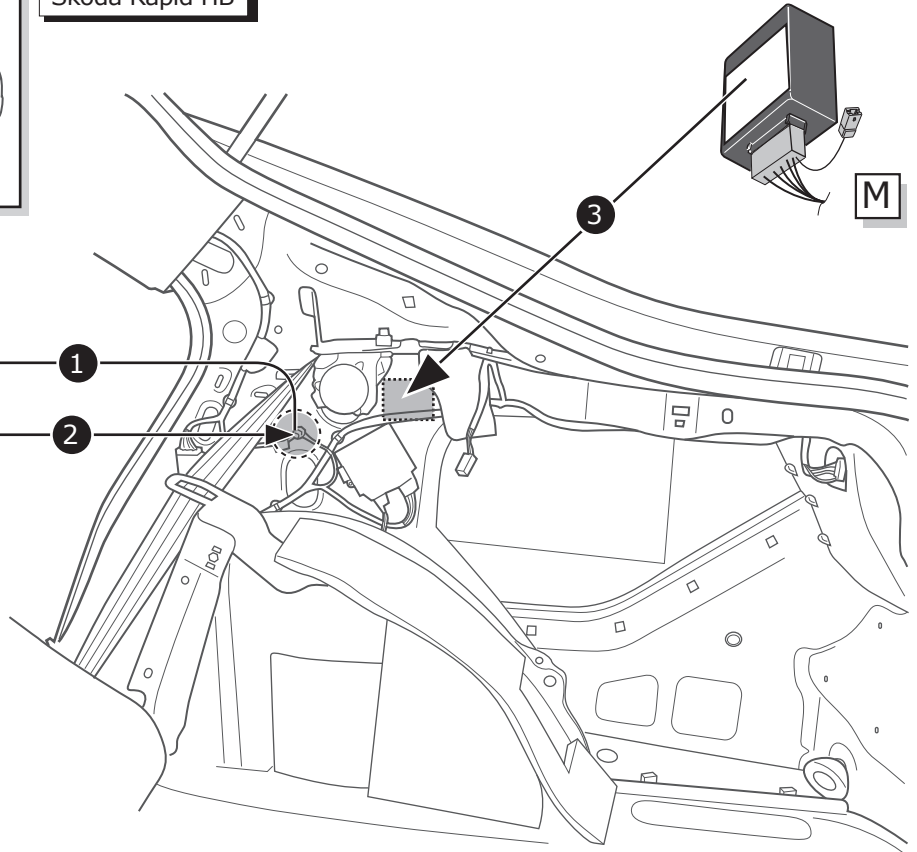

M

9

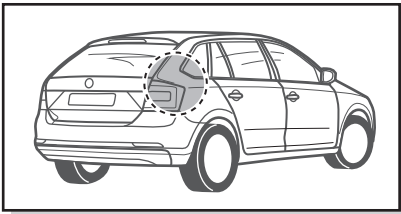

Skoda Rapid Spaceback

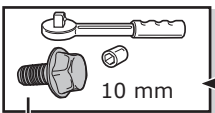

10 mm



1

2

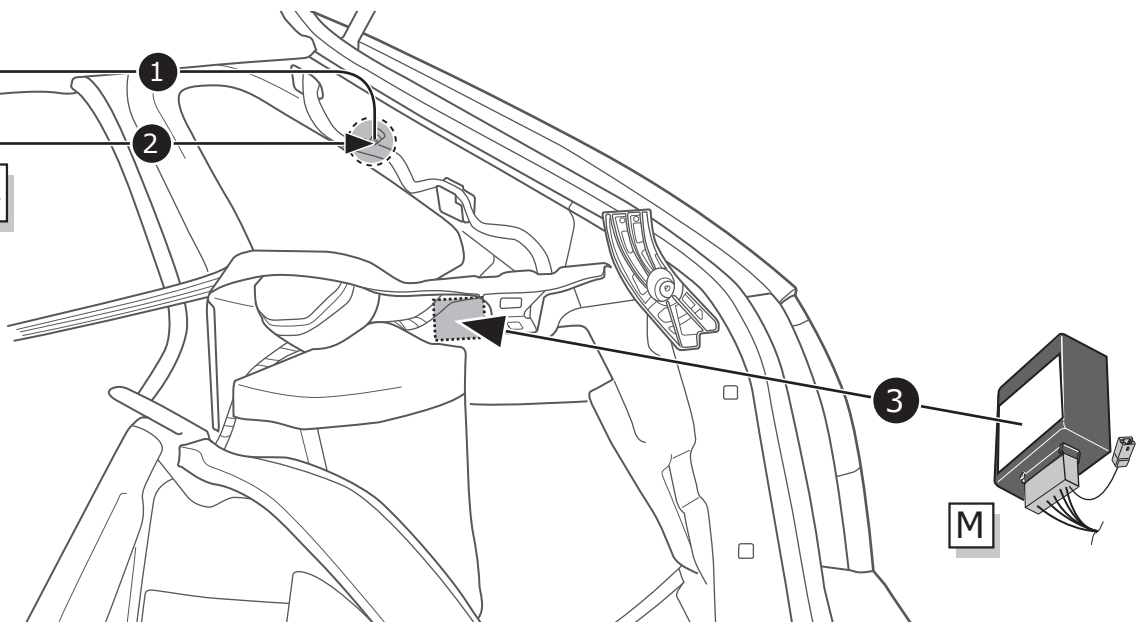

M

10

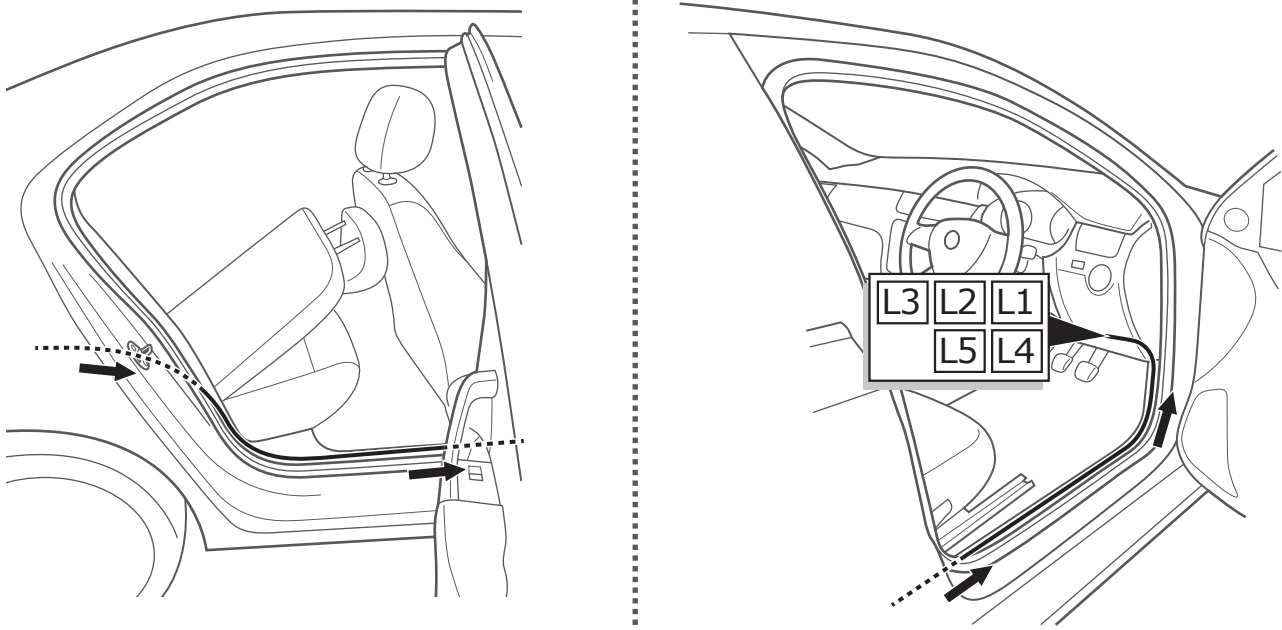

11

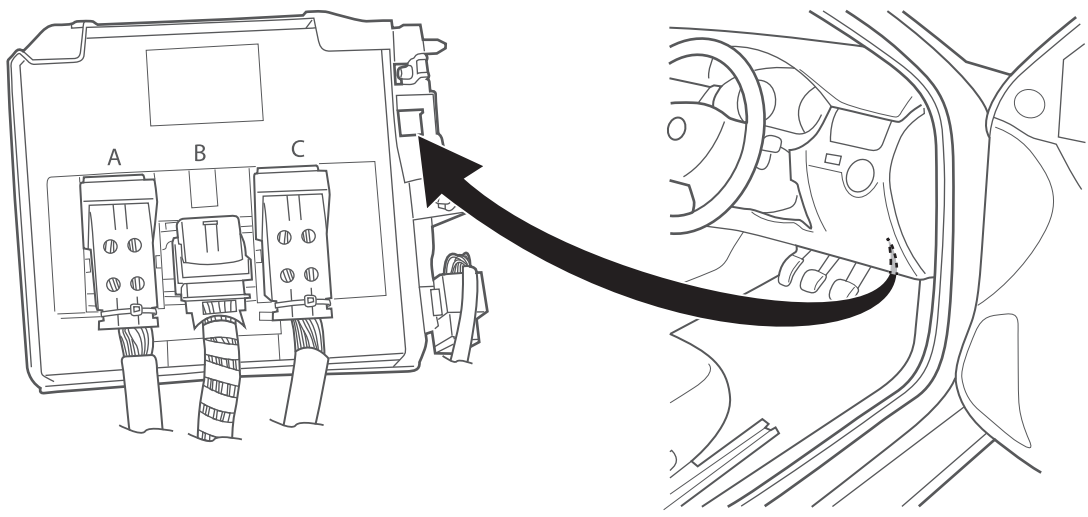

12

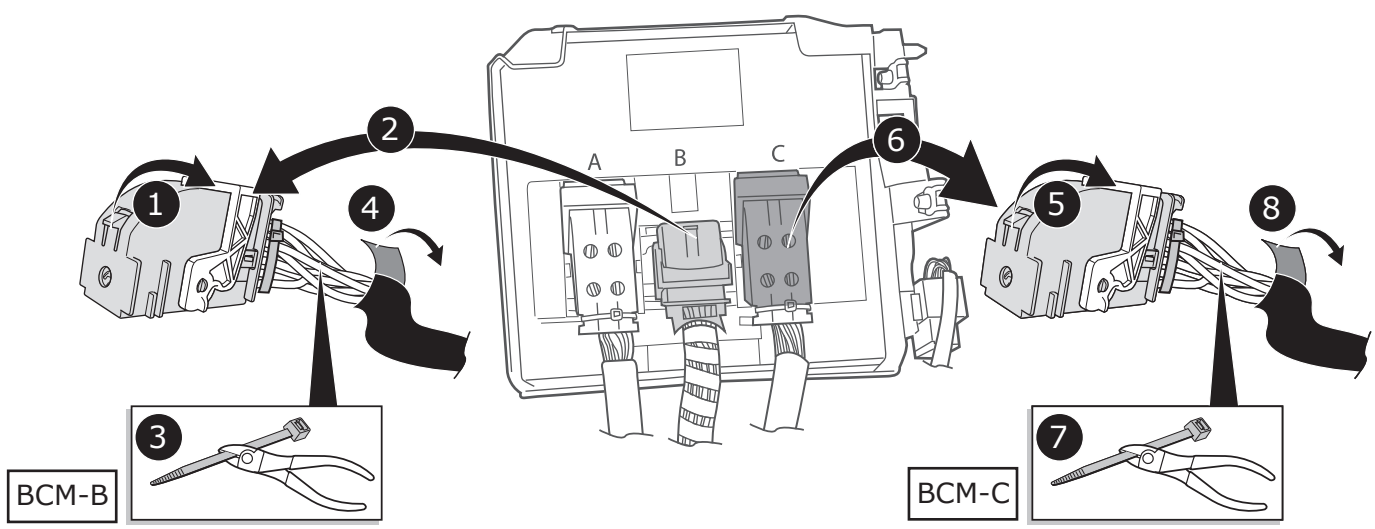

13

1

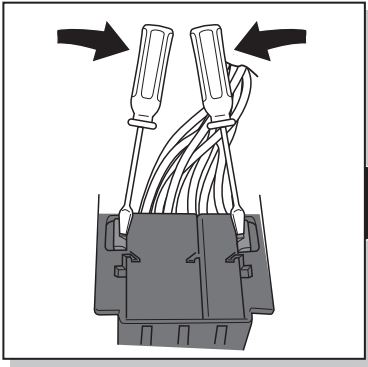

BCM-B

B

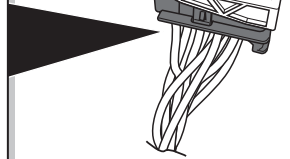

2

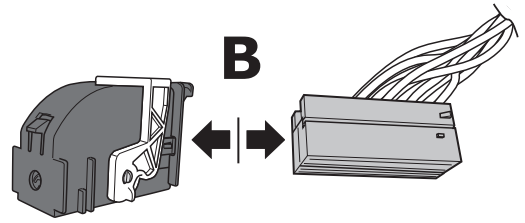

3

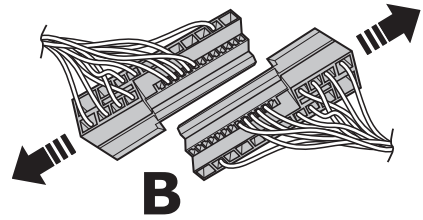

14

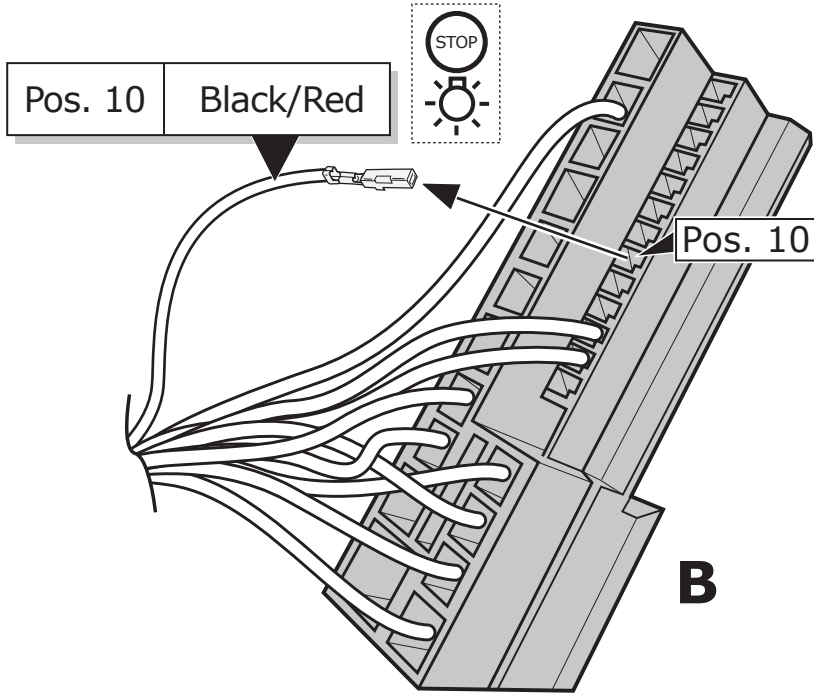

15

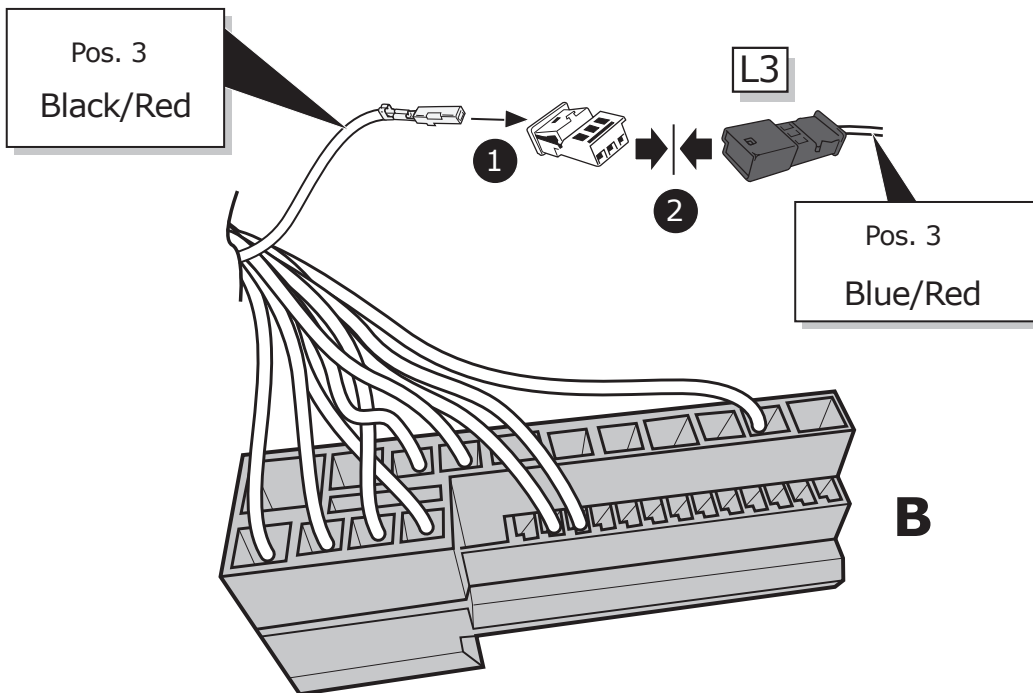

16

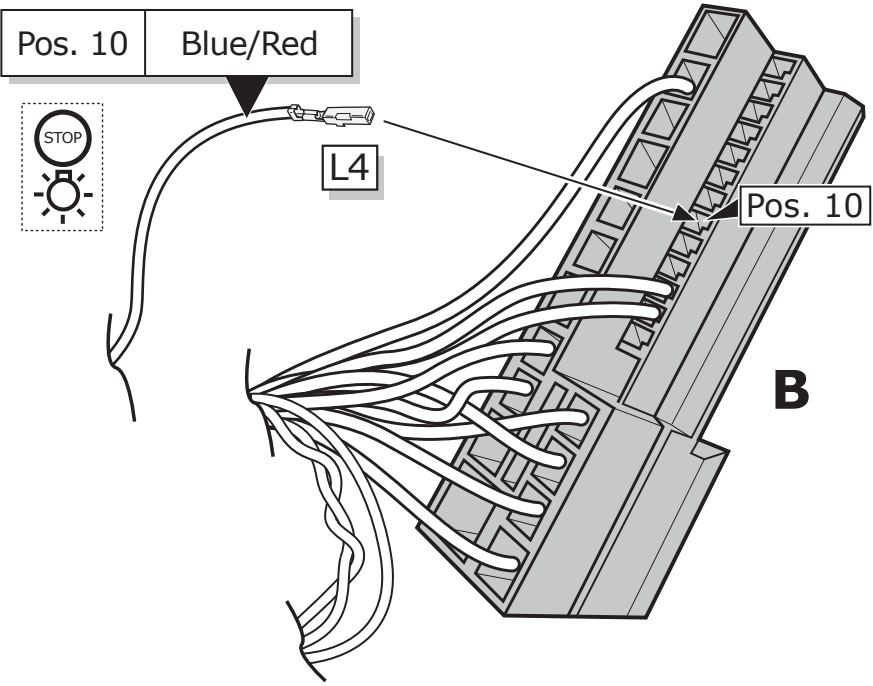

17

1

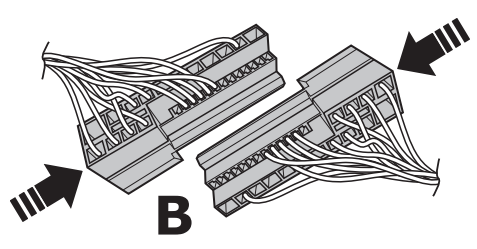

2

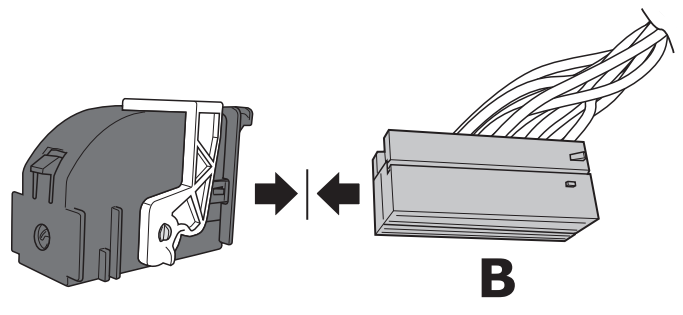

18

1

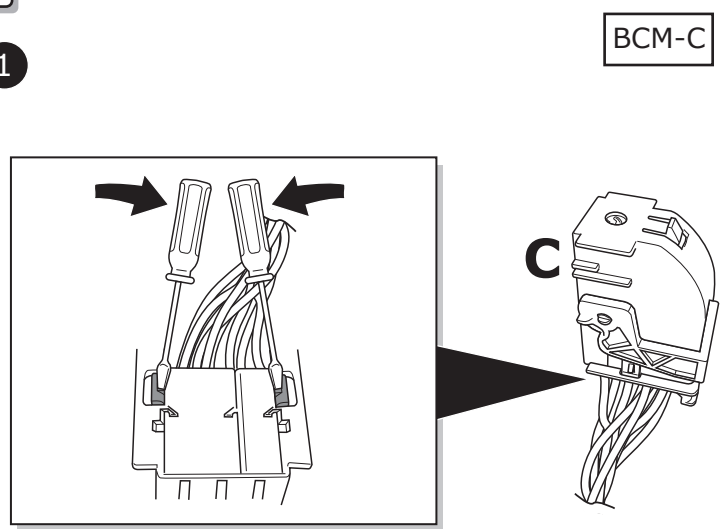

2

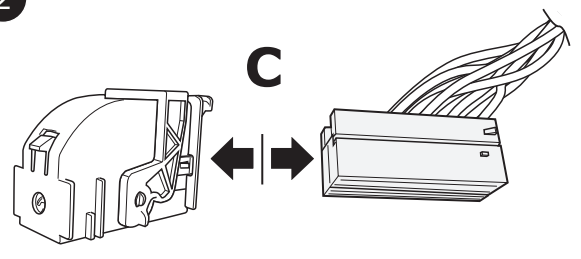

3

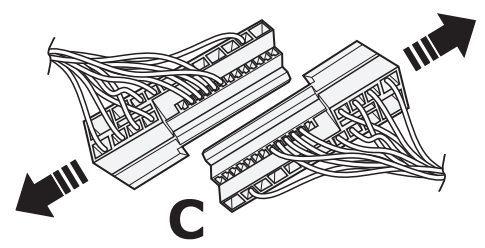

19

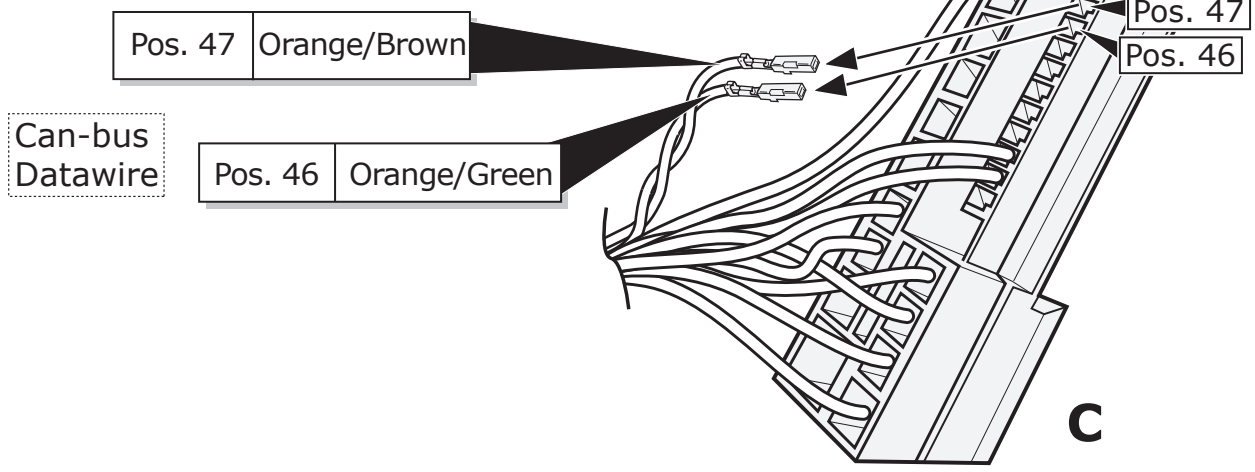

20

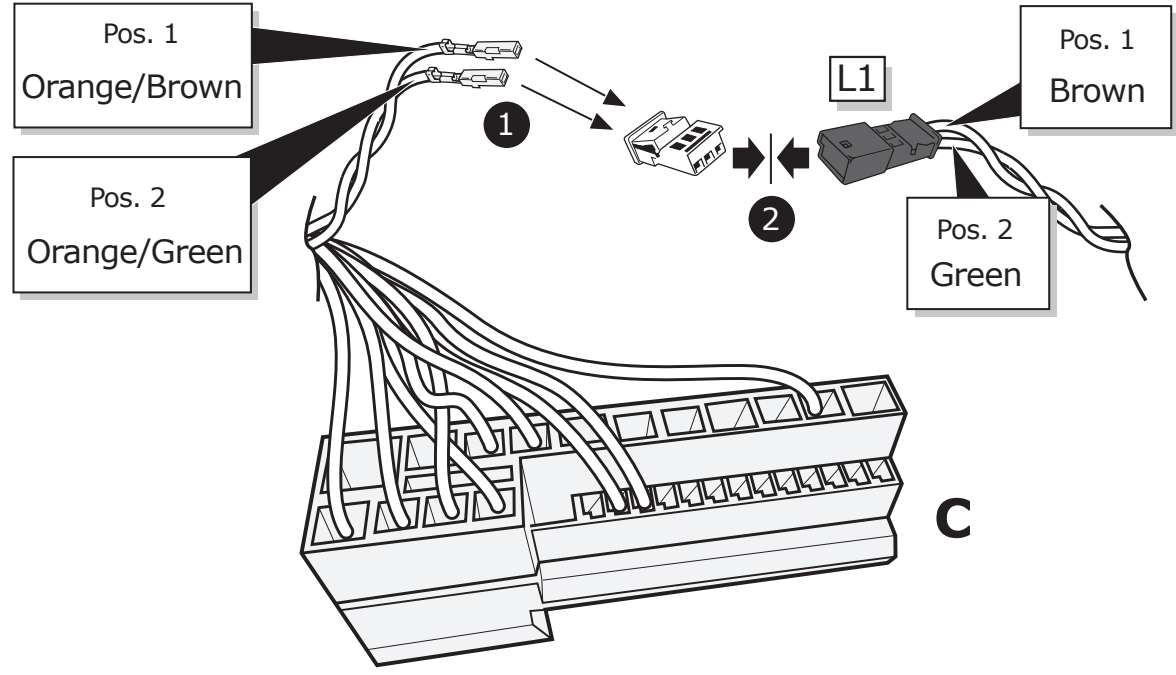

21

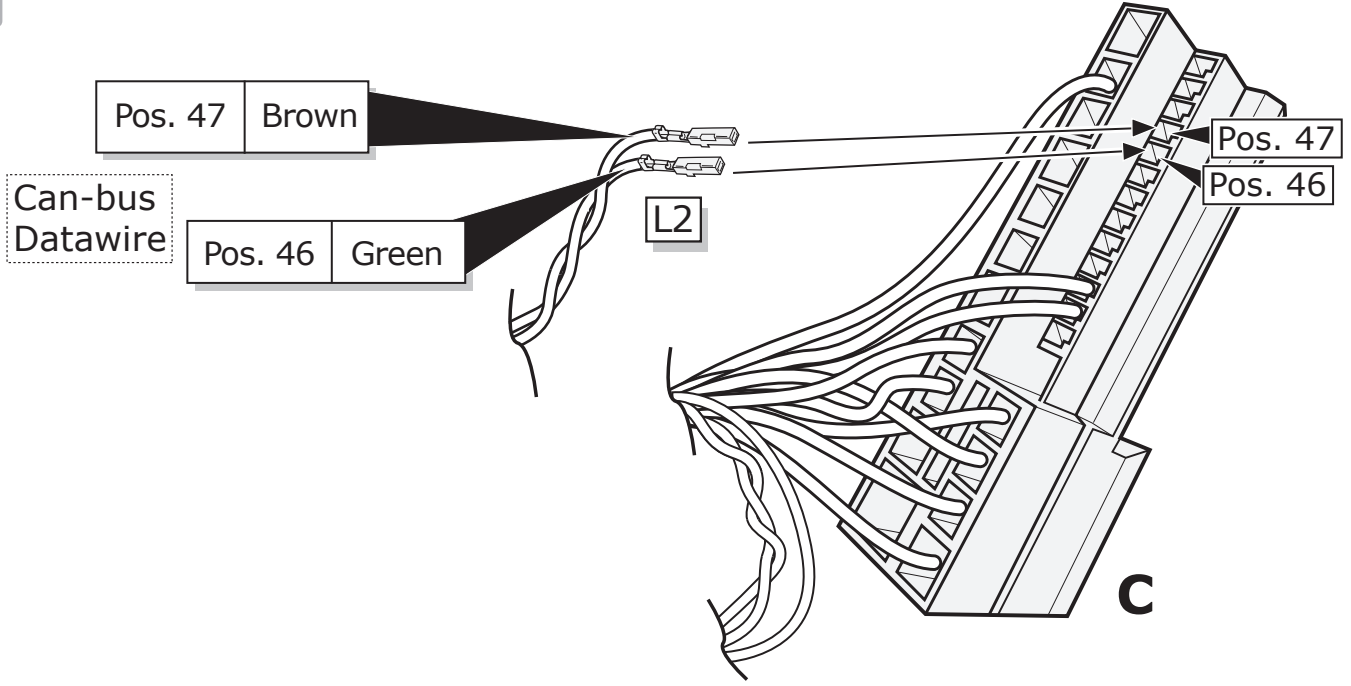

22

1

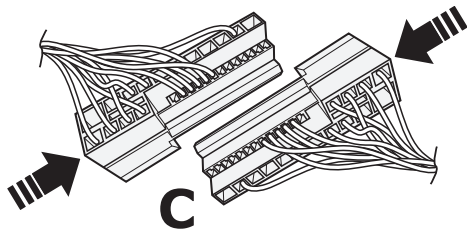

2

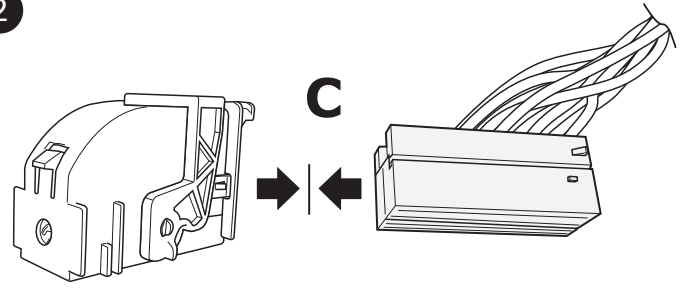

23

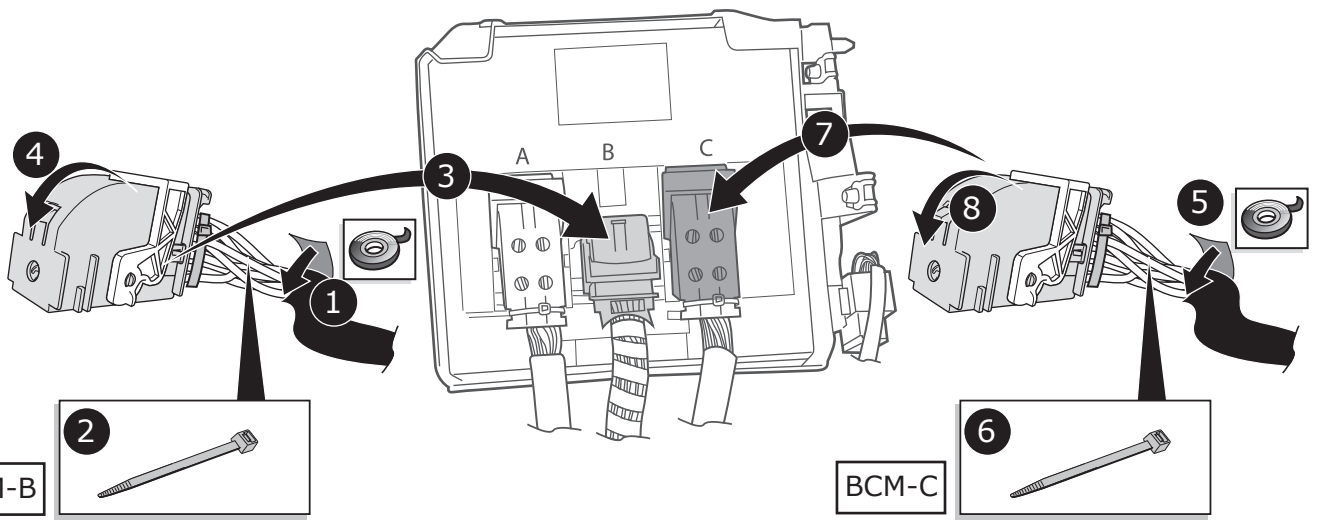

24

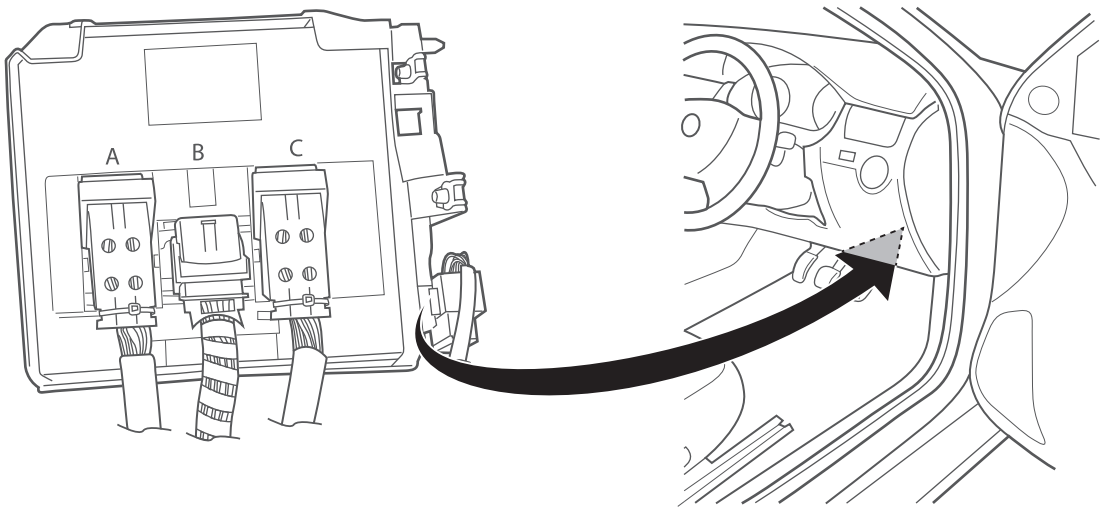

25

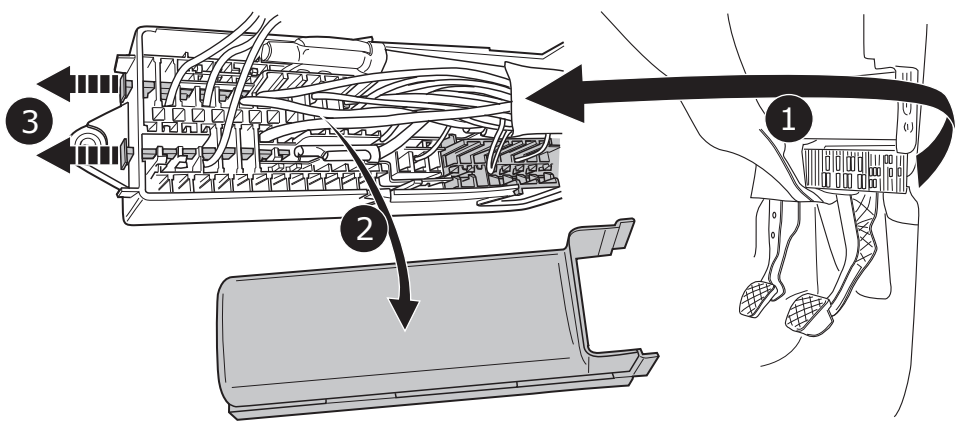

26

2

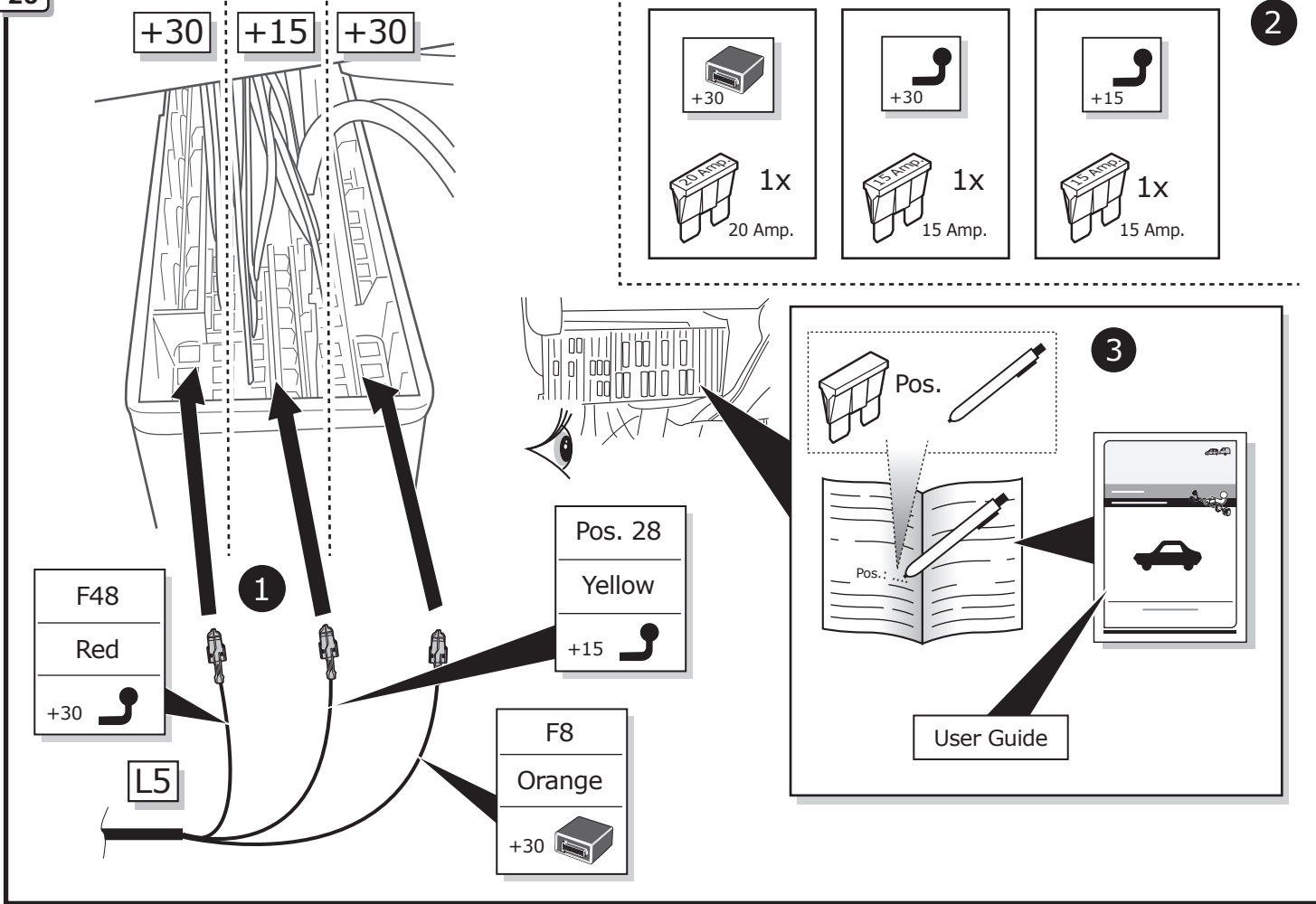

27

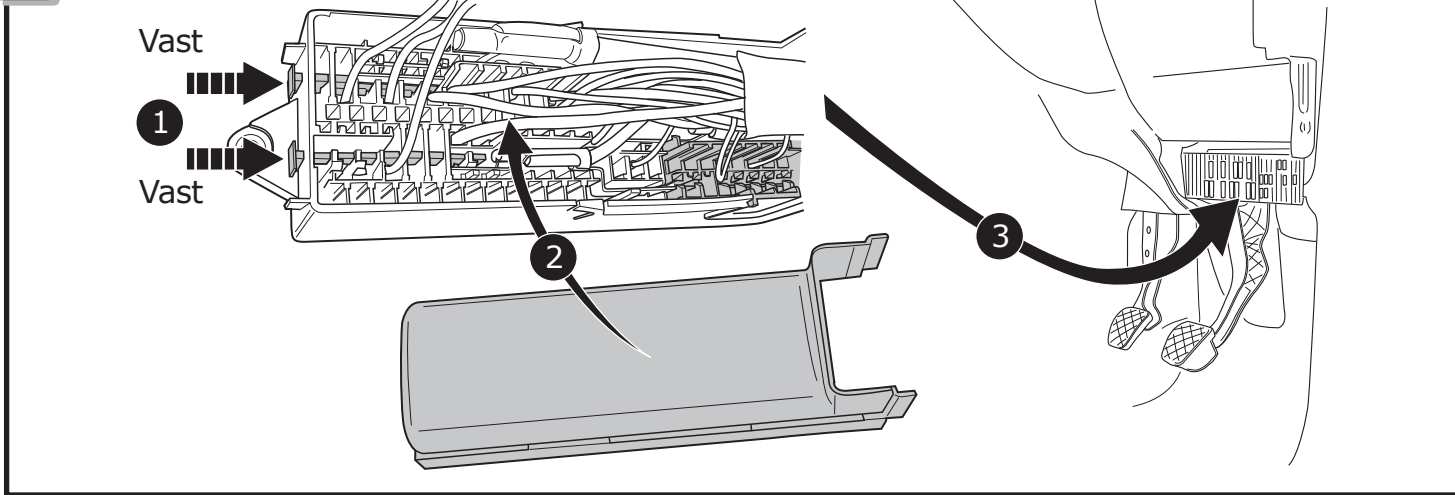

28

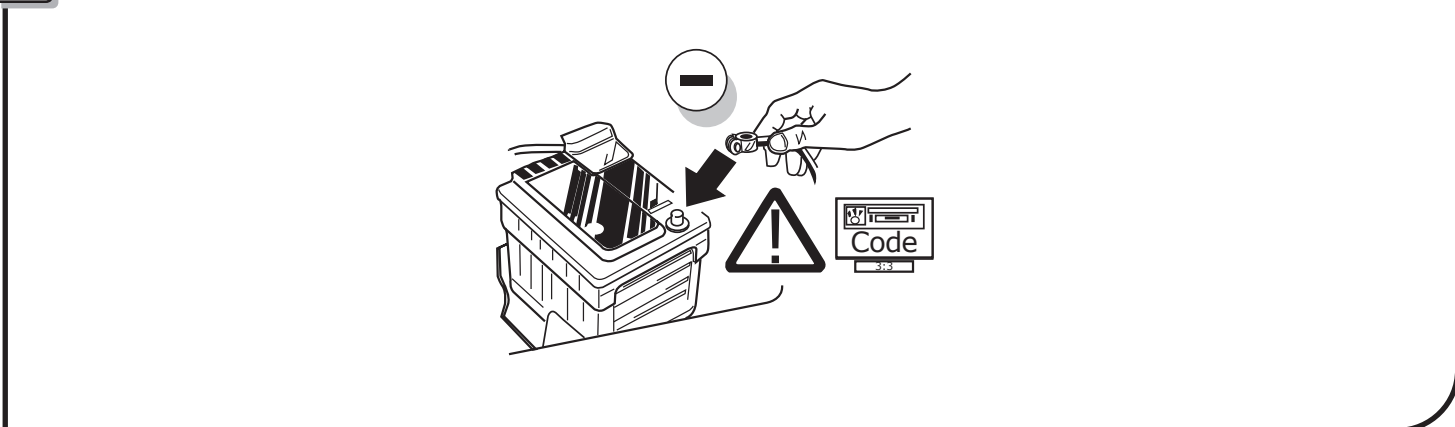

29

Online Coding procedure ONLY FOR V.A.G ODIS Tester

After installing the wiring kit please check the light functions of the Trailer/ Bike Carrier/ Caravan. They Will work without coding.

Please use SVM code: 325AA

Follow the ODIS coding instructions and close configuration.

30

TEST ALL THE CIRCUITS WITH A TEST DEVICE WITH THE CORRECT POWER LOAD FOR EACH FUNCTION. A TEST DEVICE WITH LED'S CANNOT BE USED FOR THIS PURPOSE.

INFO

REINSTALL TRIM.

31

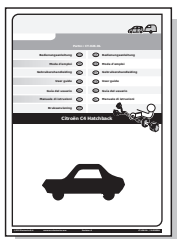
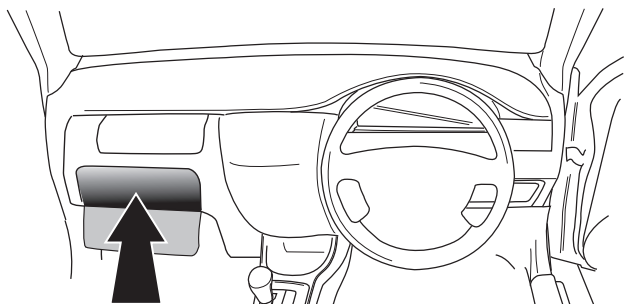

User guide



INFO

SOCKET CONNECTION

DIN/ISO 11446													
	1/L	2	3/31	4/R	5/58-R	6/54	7/58-L	8	9	10	11	12	13
Pmax	21W	21W		21W	42W	3x21W	42W	21W	180W/15Amp	180W/15Amp			
Colour	Black/White	Blue	Brown	Black/Green	Grey/Red	Black/Red	Grey/Black	Black	Red	Yellow	Brown	-	Brown