

Nissan Note (E12) 10/2013-

Partnr.: NI-096-DHU

- Fitting instructions electric wiring kit tow bar with 13-P socket up to DIN/ISO Norm 11446.
- We would expressly point out that assembly not carried out properly by a competent installer will result in cancellation of any right to damage compensation, in particular those arising by virtue of the product liability act.
- Contents of these kits and their fitting manuals are subject to alteration without notice, please ensure that these instructions are read and fully understood before commencing installation.
- Do not overload circuits; the maximum loads per connection are detailed in this manual.
- Attention! Before Installation, please read this manual carefully and inform your customer to consult the vehicle owners manual to check for any vehicle modifications required before towing.
- In the event of functional problems, troubleshooting must be limited to about 0.5 hours, contact the technical support:
t.skinner@ecs-electronics.com / 07440 202 052.



Part list

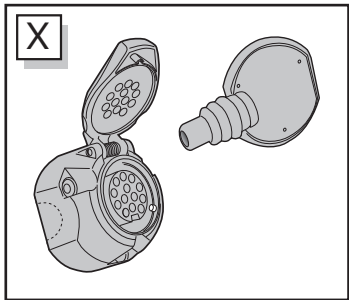
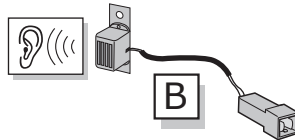
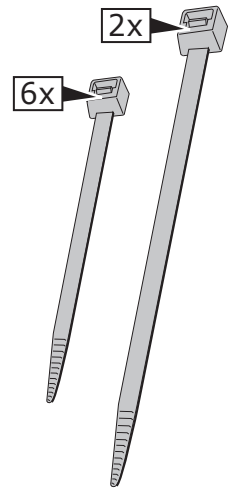
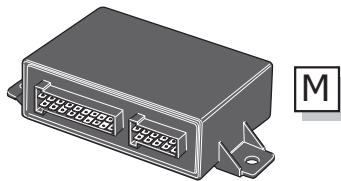
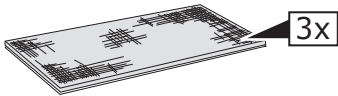
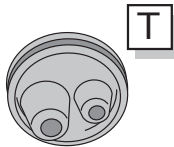
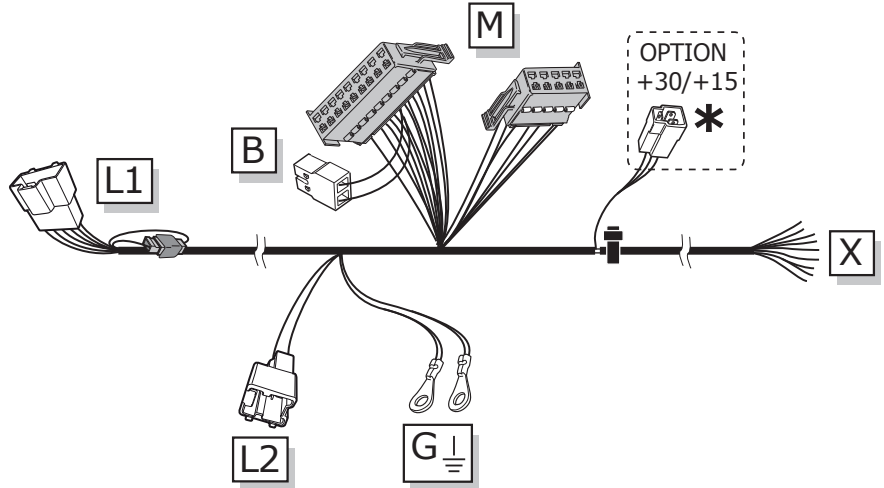
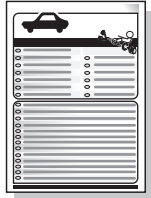
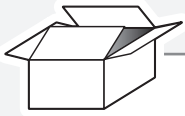

<p>* OPTION +30/+15</p> <p>preparation for</p>	<p>+30</p>	<p>+15</p>
	Brown/White	Red

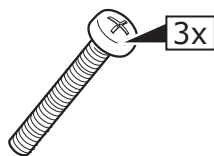

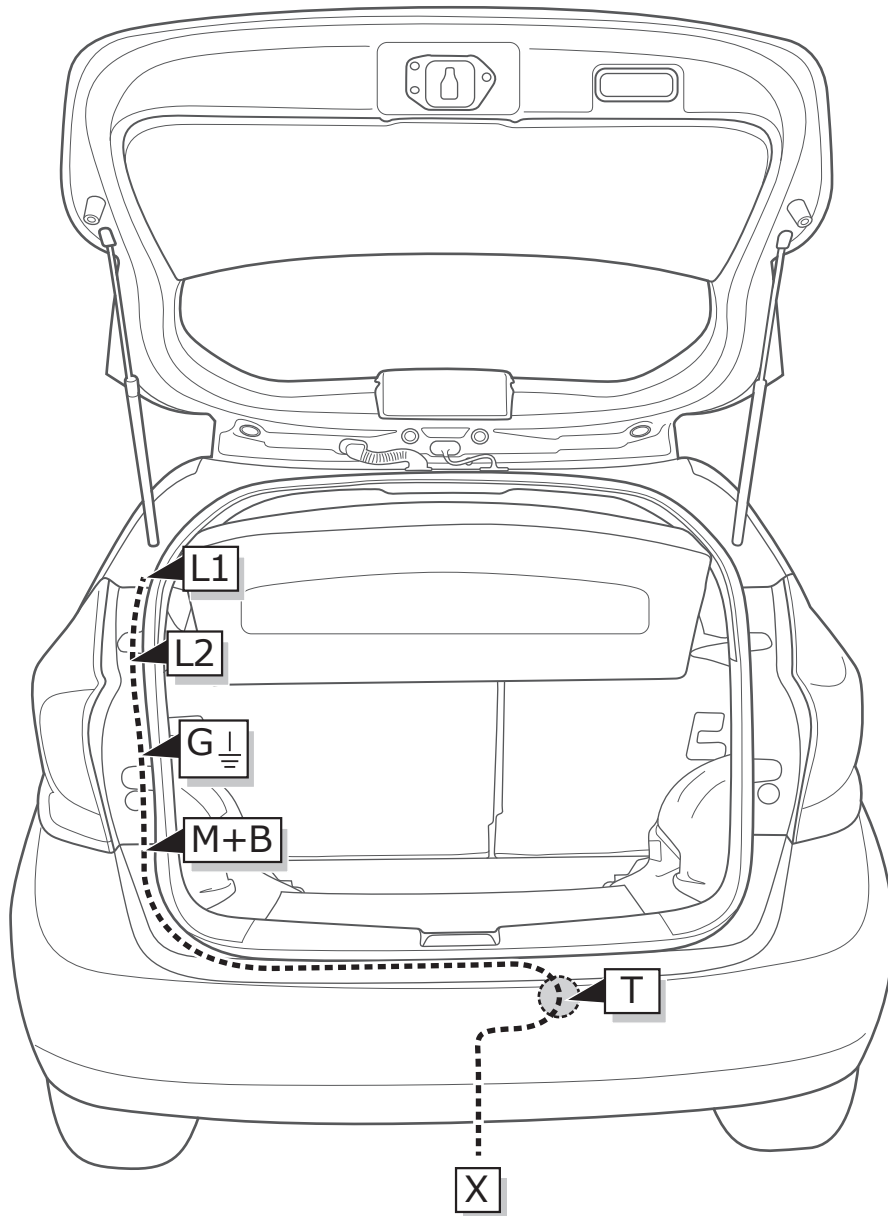

1

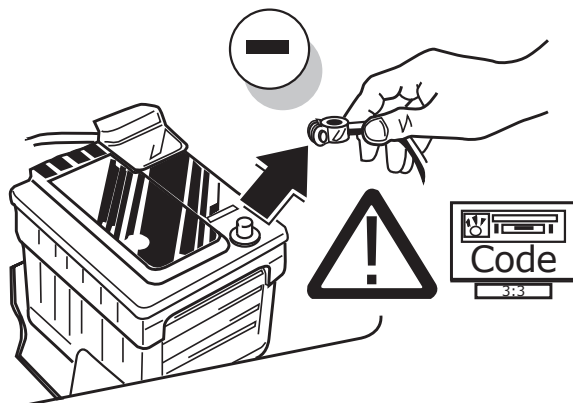

2

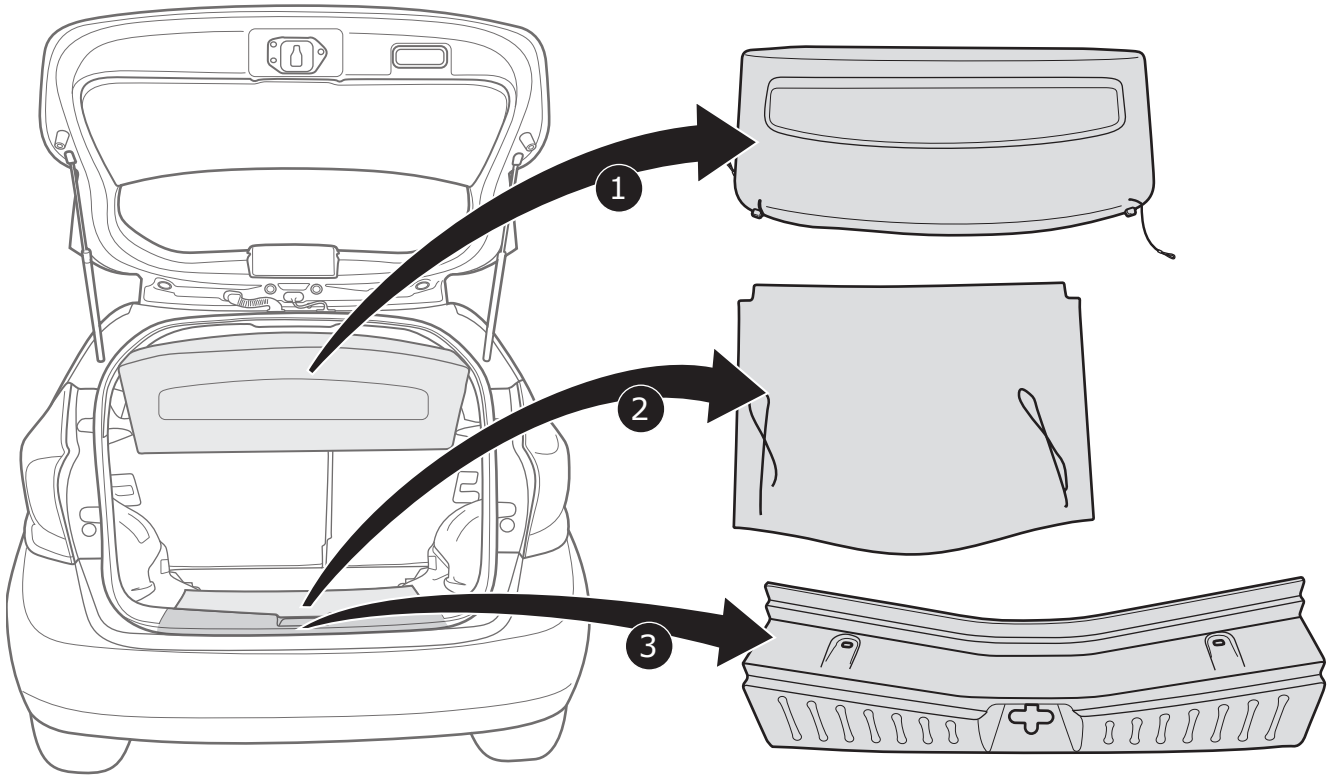

3

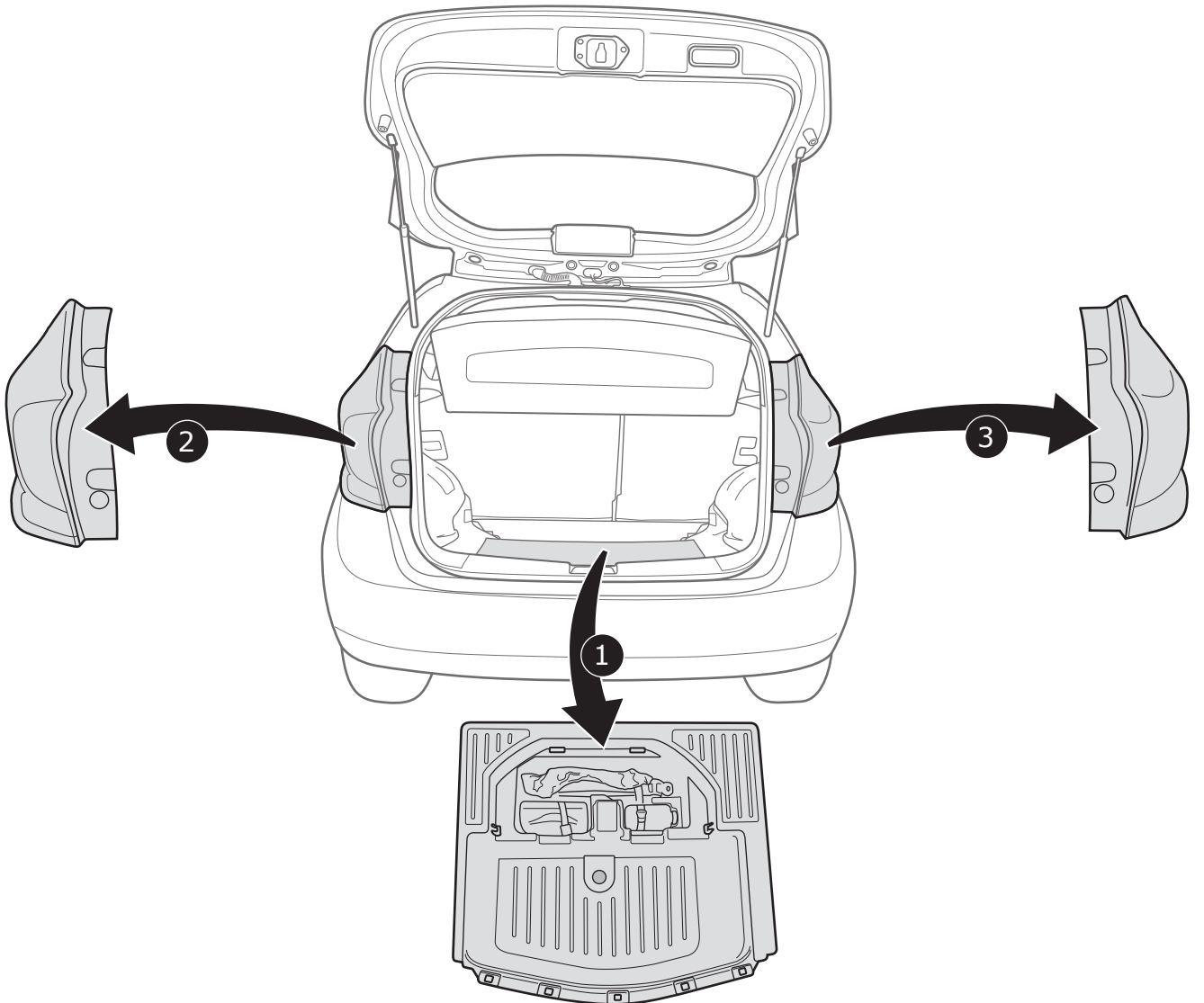

4

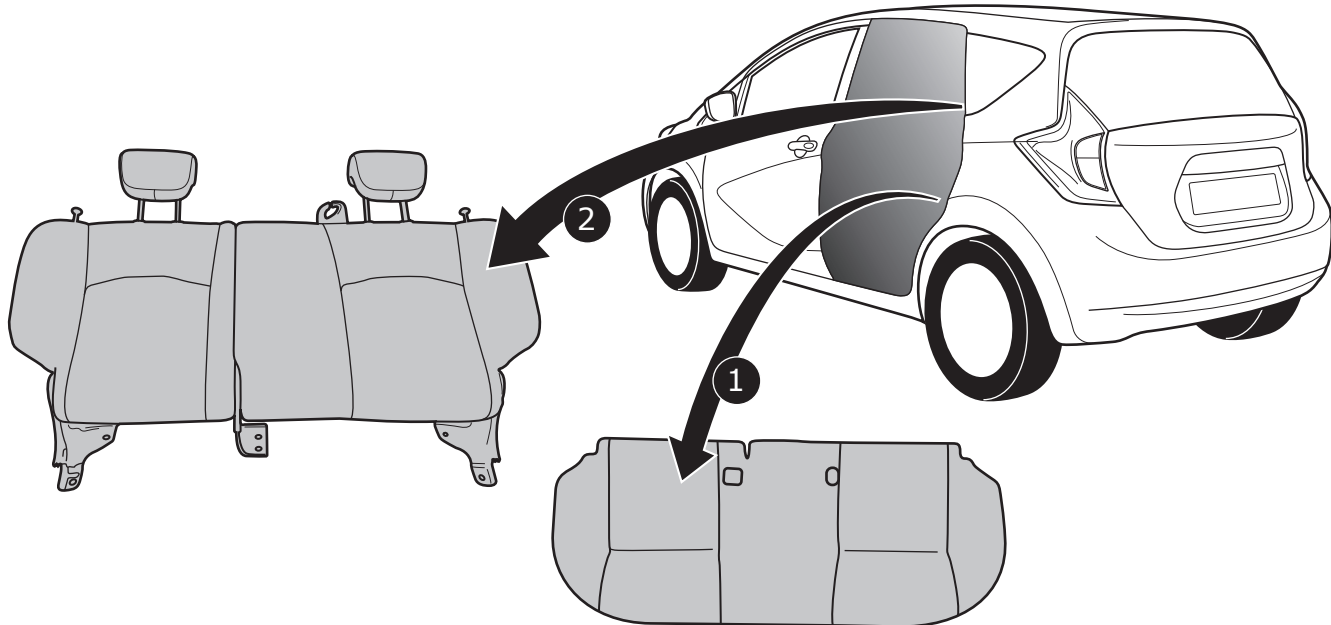

5

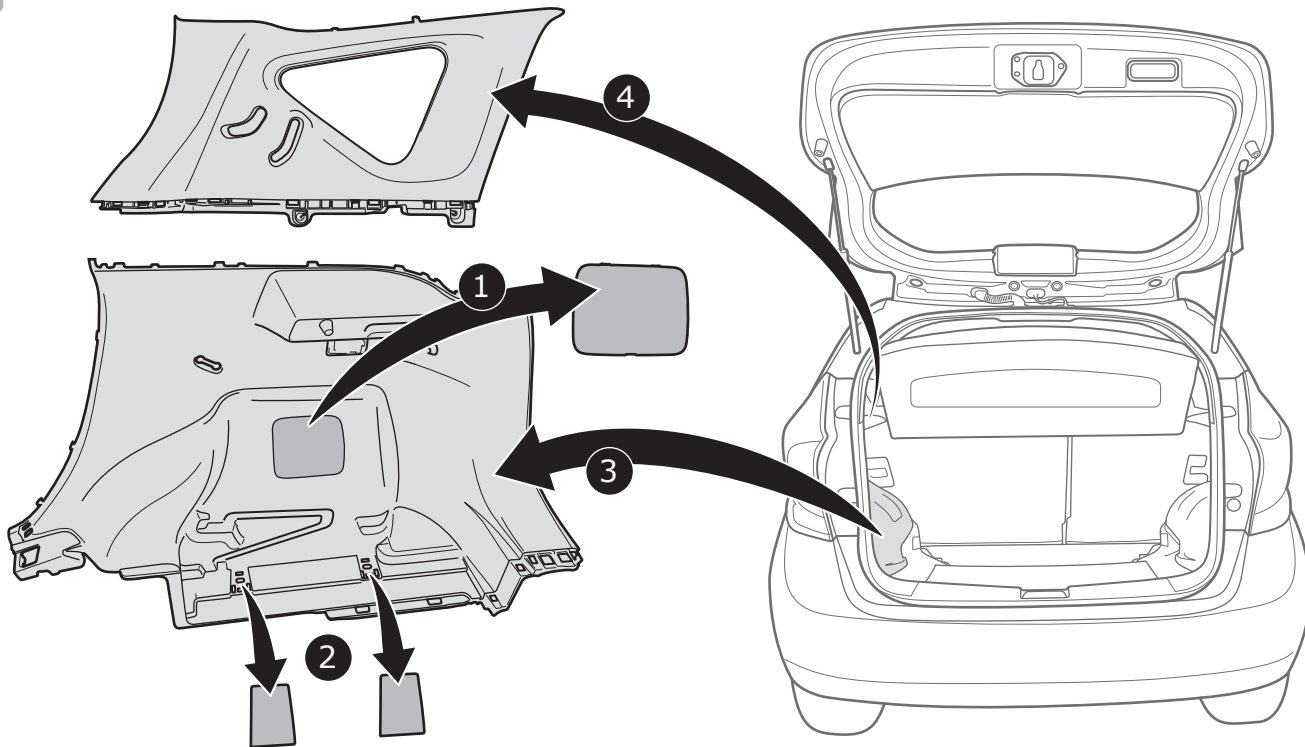

6

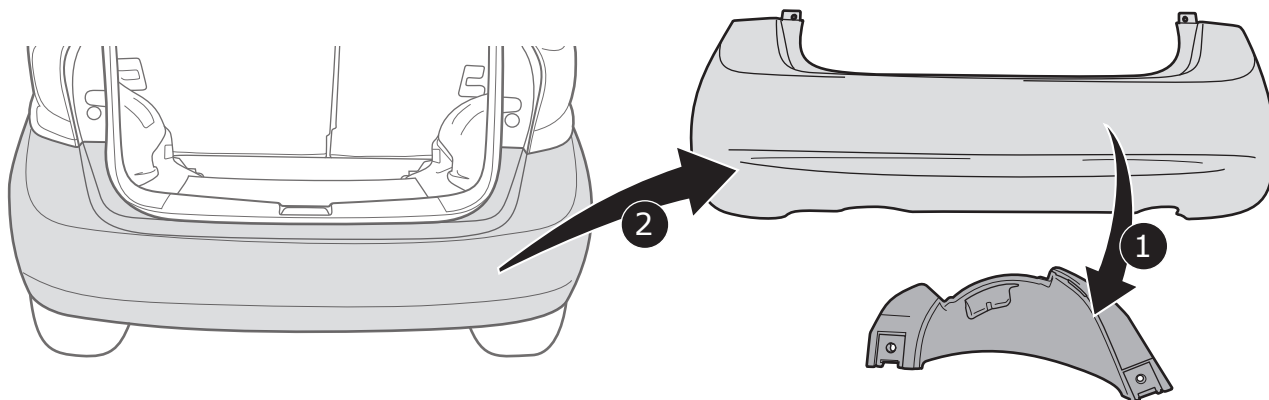

7

OPTION 1

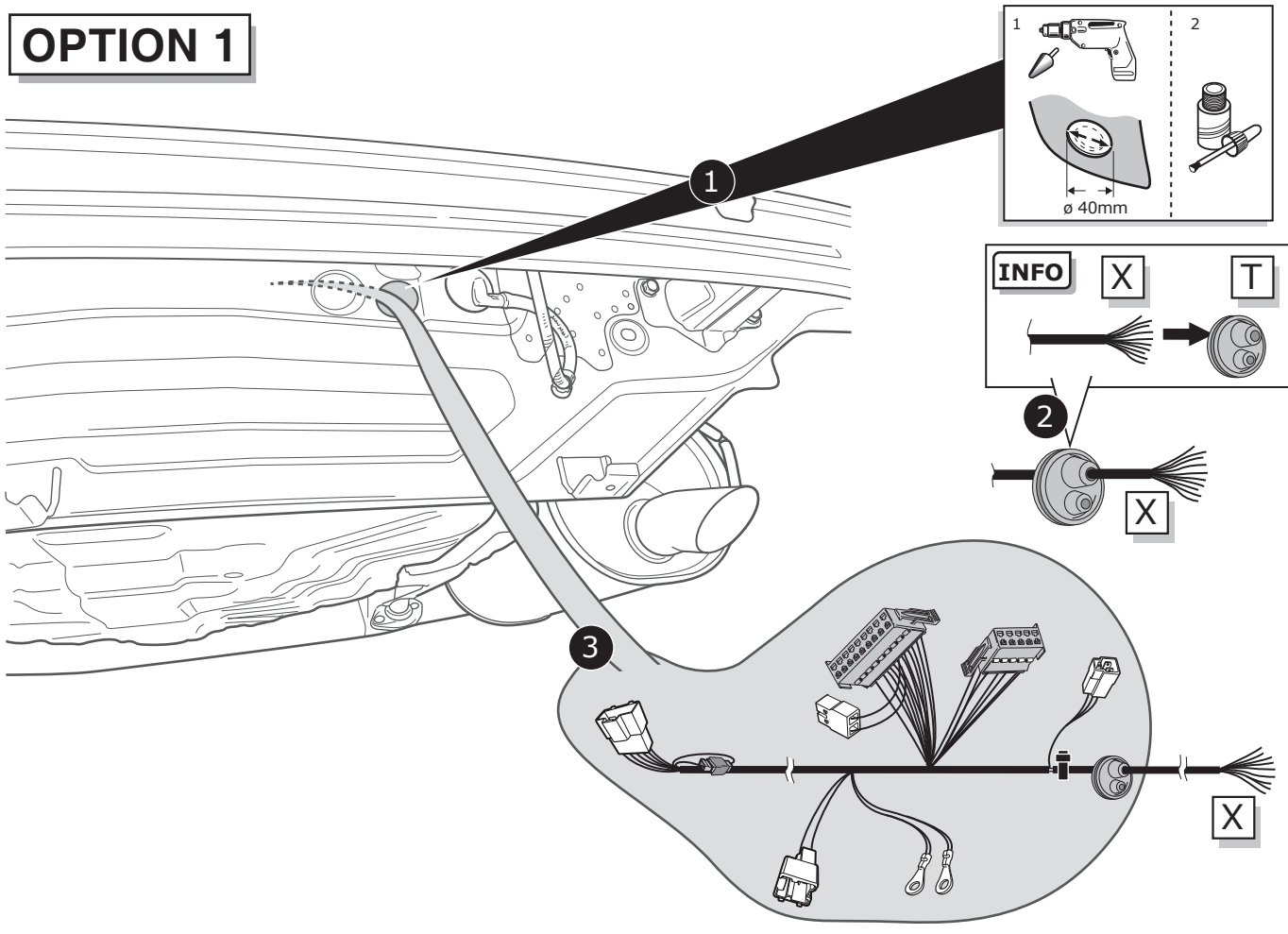

8

OPTION 2

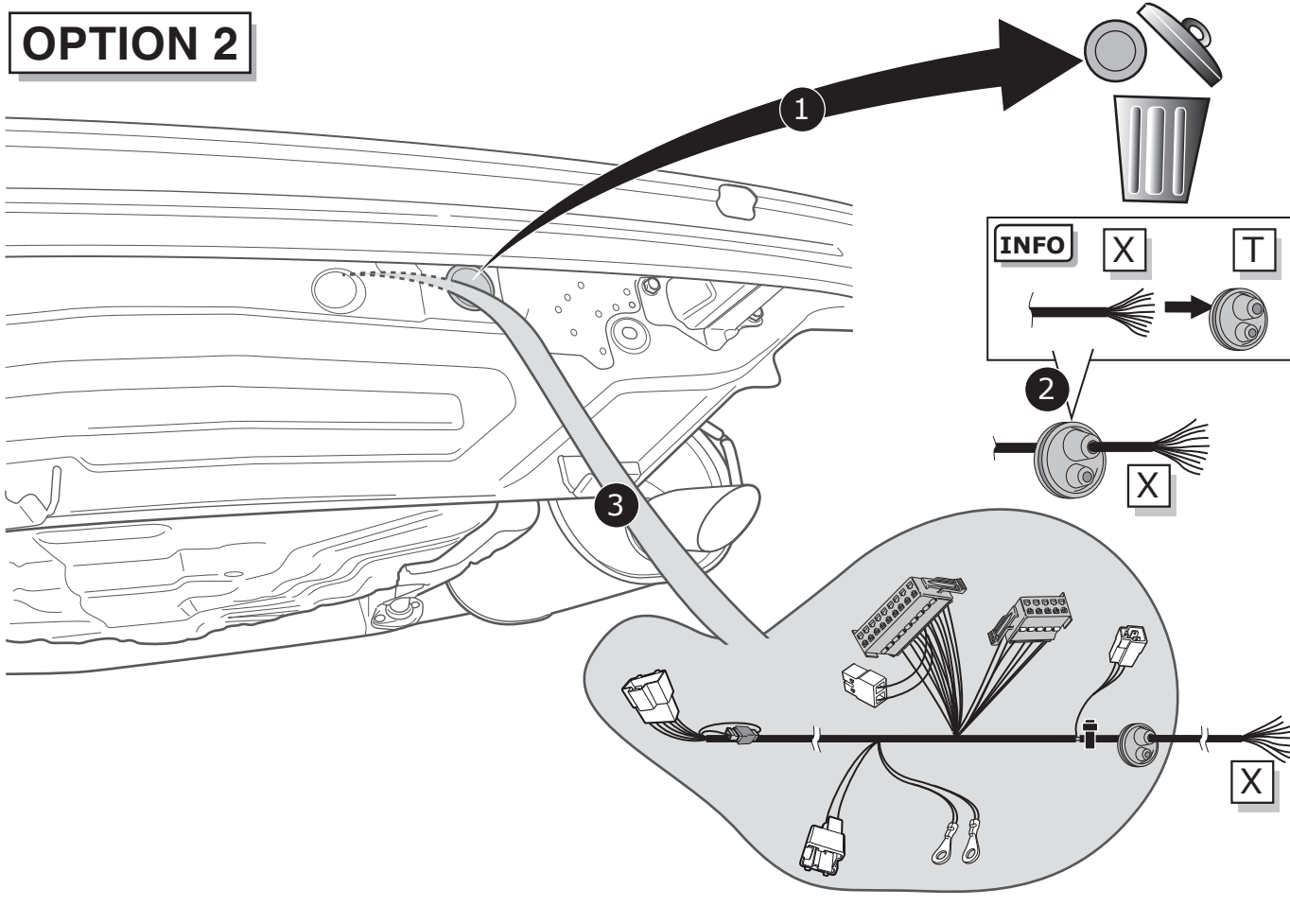

A

Option 1

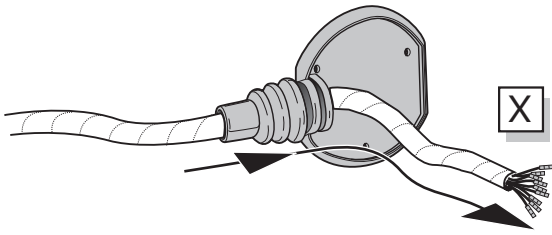

Option 2

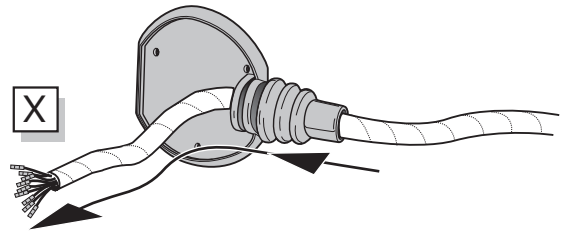

INFO

SOCKET CONNECTION 

Pag. 11

B

Option 1

1

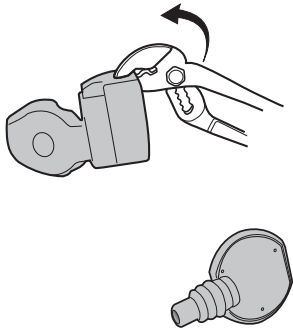

2

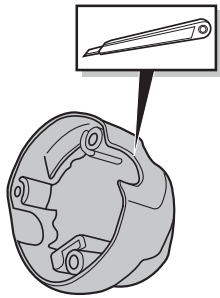

3

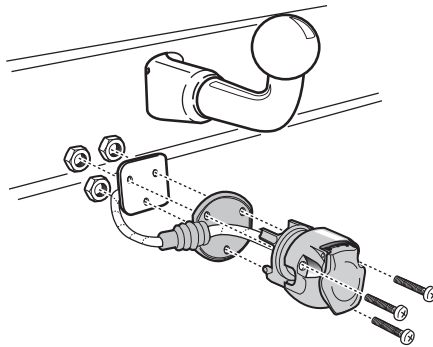

4

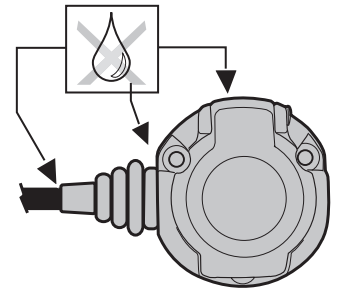

C

Option 2

1

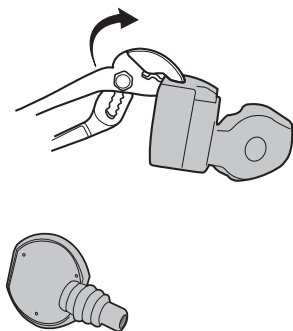

2

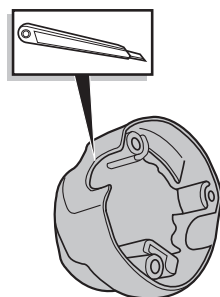

3

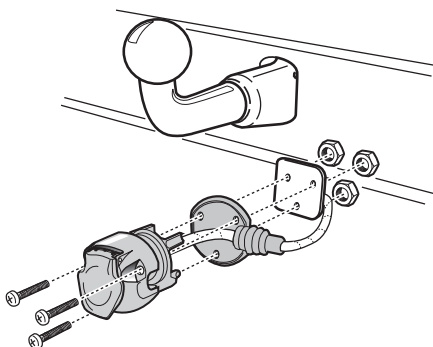

4

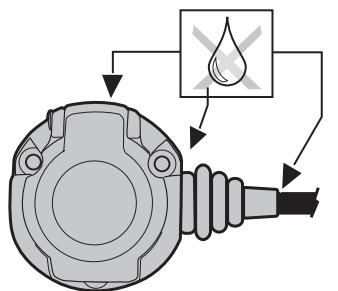

9

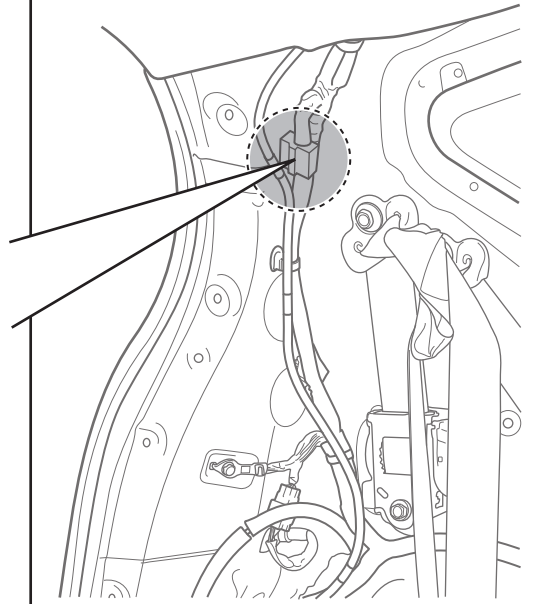
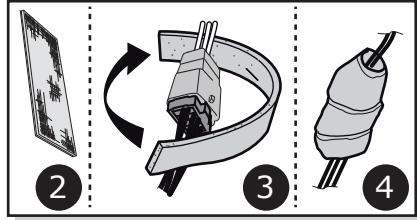
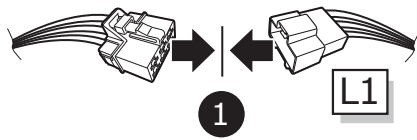
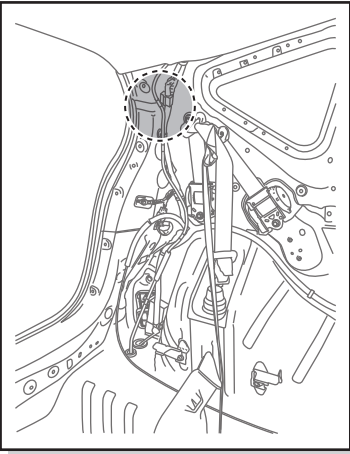

10

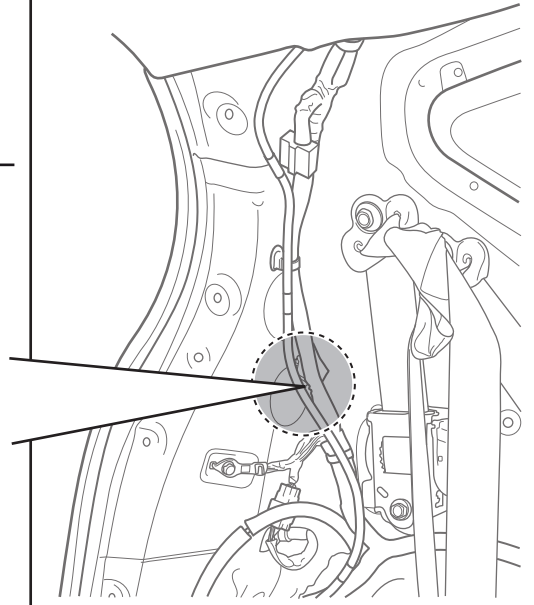
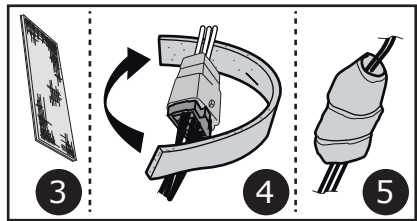
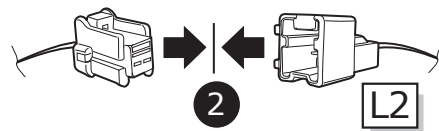
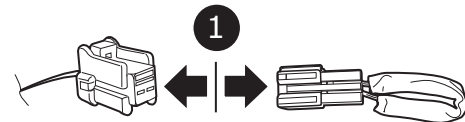
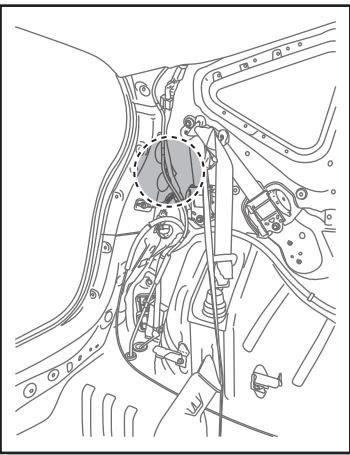

11

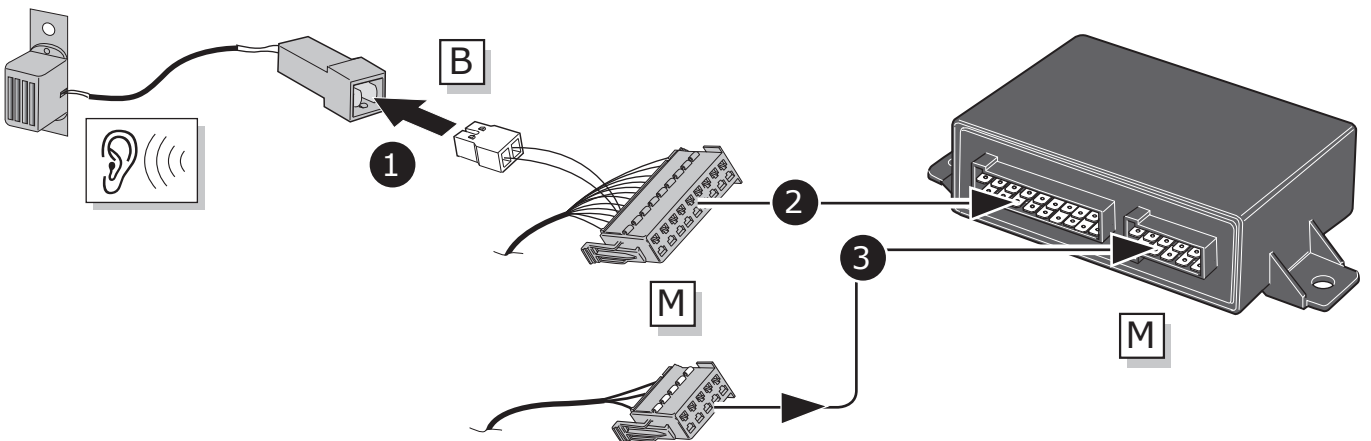

12

1

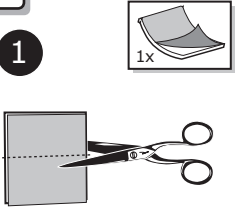

2

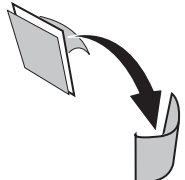

3

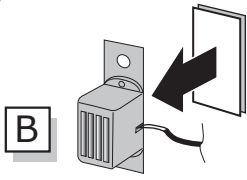

4

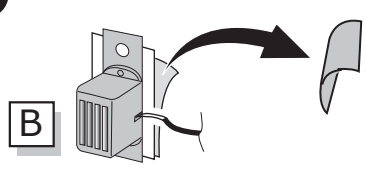

5

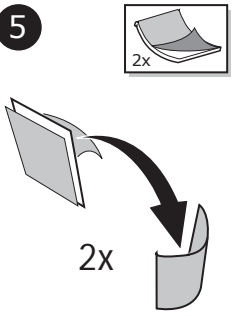

6

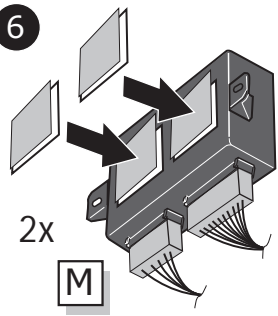

7

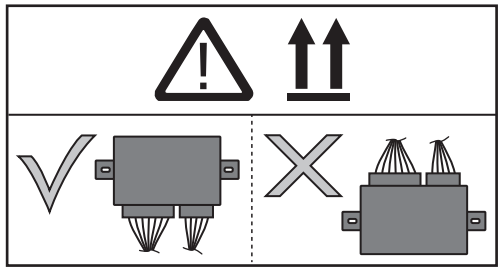
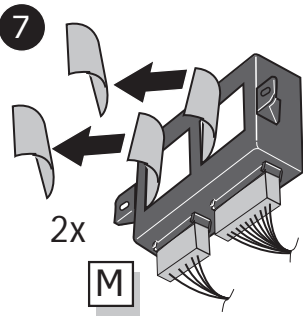

13

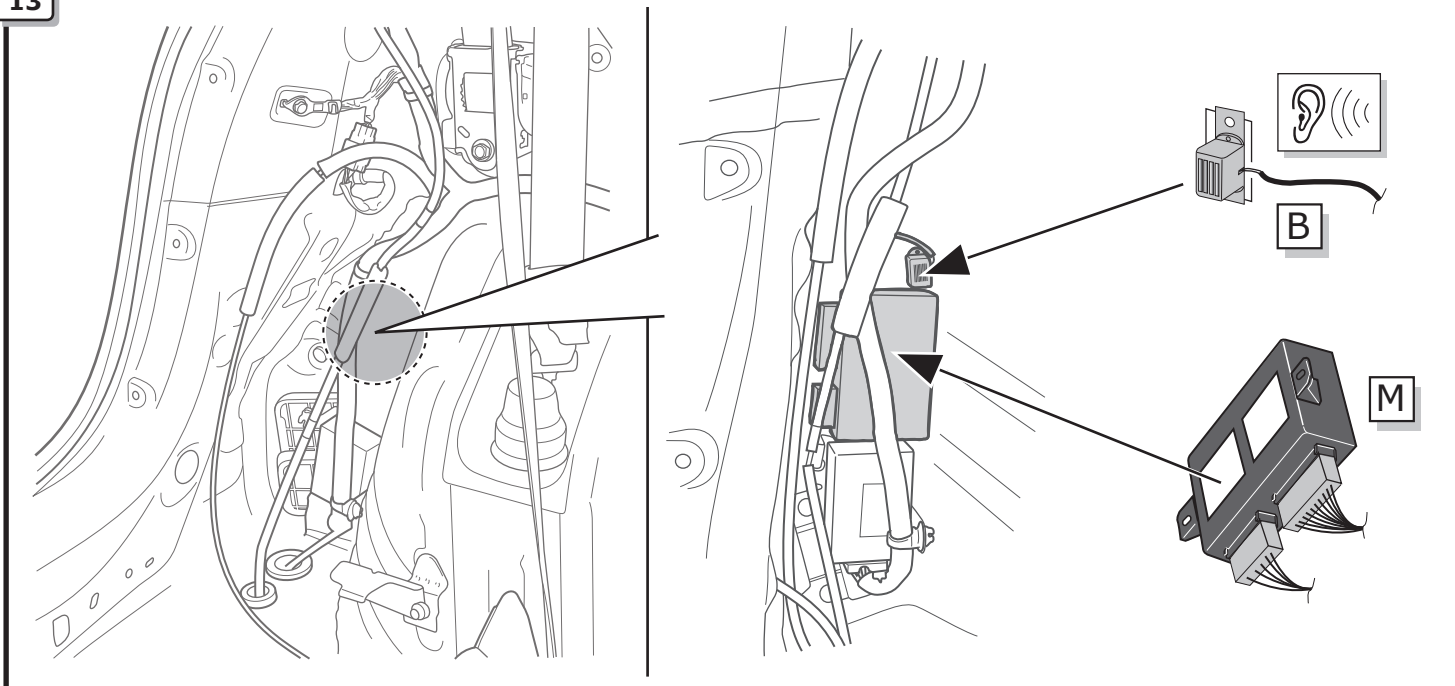

14

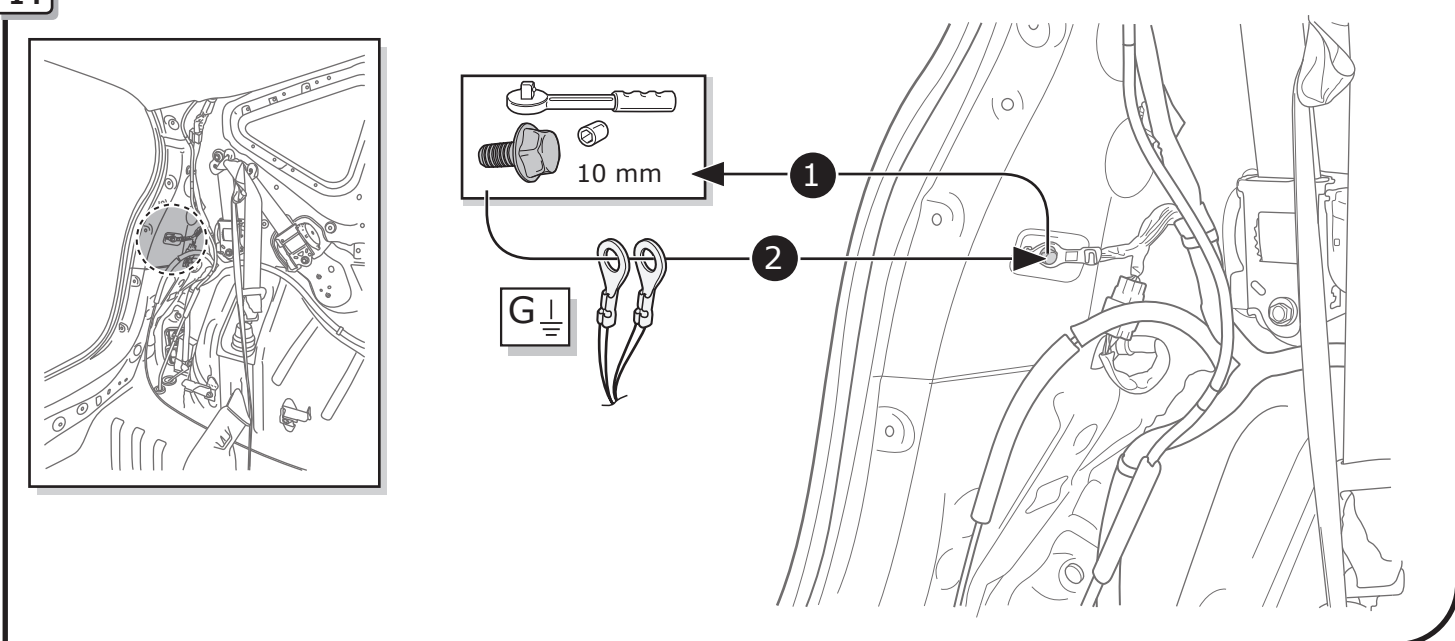

15

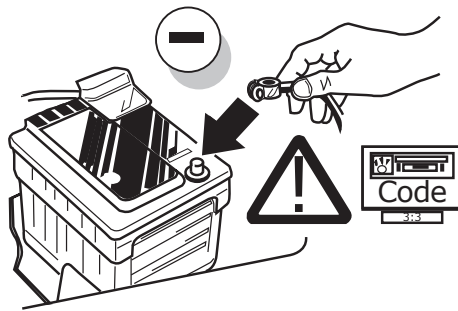

16



TEST ALL THE CIRCUITS WITH A TEST DEVICE WITH THE CORRECT POWER LOAD FOR EACH FUNCTION. A TEST DEVICE WITH LED'S CANNOT BE USED FOR THIS PURPOSE.

INFO

REINSTALL TRIM.



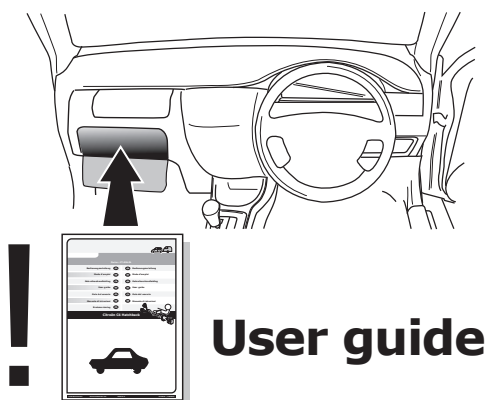









17



User guide

A graphic for technical support. It features a large headset icon in the center. Above the headset, the text 'CALL 07440 202 052' is written. A diagonal banner in the top left corner says 'TECHNICAL SUPPORT'. At the bottom, the ECS Electronics logo is shown, along with contact details: 'MONDAY TO FRIDAY 08.00 - 11.00 am 12.00 - 05.00 pm', an email address 't.skinner@ecs-electronics.com', and a website 'www.ecs-electronicsuk.co.uk'.

SOCKET CONNECTION

DIN/ISO 11446												—	
	1/L	2	3/31	4/R	5/58-R	6/54	7/58-L	8	9	10	11	12	13
Pmax	21W	2x21W		21W	52W	3x21W	52W	2x21W	180W/15Amp	180W/15Amp			
Colour	Yellow	Blue	White	Green	Brown	Red 1,00 mm ²	Black	Black/ Red	Brown/ White	Red 2,50 mm ²	White	-	White